

GEARS



103361



155819B



155819W



163328



163329



163996



163997



174204



174488



446021



174491



174491(s)



319695 (NL)



445460



445491



445491-s



445817

BOBBIN CASE



1910



86132



87061



137322



XC3153031



395713-33



395719-69



XC3153051



XC3153151



XC3153351



XC3152221



1275000



627569003



627569106



XC0066051



421325



421325(steel)



421326



421326(steel)



172082-8

PRESSER FEET



CY-701



CY-702



CY-703H



CY-703L



CY-704



CY-705H



CY-705L



CY-706H



CY-706H0



CY-706L



CY-706L0



CY-707



CY-707R



CY-708



CY-709



CY-710



CY-711



CY-712



CY-714



CY-714L



CY-716



CY-717-1H



CY-717-1L



CY-717H



CY-717L



CY-718L



CY-719H



CY-719L



CY-720H



CY-720L CY-722H CY-722L CY-723H CY-723L CY-7300



3700L 7301P 153267 446371 CY-7300 CY-7301



CY-7301H CY-7301L CY-7301W CY-7302 CY-7303 CY-7304



CY-7305 CY-7305L CY-7306 CY-7307 CY-7307H CY-7308



CY-7309 CY-7310 4021P 137627 153267 155964



313992 317298 445464 446492 507836 4450900

ROTARY HOOK



HSH-7.94A KHS12-R HSH-7.94B KHS12-S HSH-7.94C KHS12-G(T) HSH-7.94ATR KHS12-RP HSH-7.94BTR KHS12-SP



HSH-7.94BOH KHS12-GTH HSM-B1H KHS20-GB HSM-A1 KHS20-RTP HSM-ATR(1Q) KHS20-RMP HSM-BIQ1TR KHS20-SPNP GC2603



GC6-10 HSH-7.94A(MTQ) KHS12-RY HSH-7.94ATR(MTQ) KHS12-RYP HSH-7.94A(MTQTS) KHS12-RYN HSH-7.94ATR(MTQTS) KHS12-RYPN HSM-A(MTQ) KHS20-RY



HSM-ATR(MTQ) KHS20-RYP HSM-A(MTQTS) KHS20-RYN HSM-ATR(MTQTS) KHS20-RYPN DB1-Z16 KR24 DB1-Z16B KR24-B DB1-Z(20) KR24-U



DB1-BZ(20) KR24-US DB1-Z(20L) KR24U-42 DB1-BZ(20L) KR24U-31 DA1-A KR21-R DA1-B KR21-S DA2-A KR11-R



DA2-B KR11-S HSH-31 KRT31-R HSH-31(6) KRT31-NP HSH-32 KRT132 HSH-33 KRT133 HSH-36-2 KRT236



HSX-10-100 HSH-10-100A KRT110 HSH-12-15MM(S) KRT211-L HSH-21-40(J) KRT21-J HSH-21-40(AJ) KRT21-R HPF-134 KRP134



HPF-151 KRT151-S HPF-190 KRT190-G HPF-238 KR238 HPF-335 KR69 HPF-335(5) KR69-V HPF-345 KRT345



HPF-390 KRT390 HPF-418 HPF-480 KHS-480 HPF-490(A) KRT470-R HPF-490(A)TR KRT490-R HPF-490 KRT470-S



HPF-490TR KRT490-S HPF-490(A)5)TR KRT470C-R HPF-545 KRT545 HPF-545(B) KRT545-G HPF-563TR HPF-591



HAD-467TR KRT467 HDU-271 KHS271-S HUN-614B DP2-107 KRP41-S DP2-57(2) KRP457 DP2-57(2LP) KRP457-W



DP2-57(3LP2V) DP2-800(FR) DP2-815 DP2-LB KRP41-B DP2-NJ KRP41-LH DP2-NJ771 KRP771



DPZ-NJ(790) HPF-3114 KRP3114 HSH-12-15M KRT12-5M HSH-12-15L KRT12-5B HSH-12-15L(H) KRT12-5BH HSH-12-15LC KRT12-5BK



HG12-15L KRT842F-S HG12-15LC KRT845BK HG12-15L(H) KRT842H-S HG12-15L(TR1) KRT842CI HSH-12-15(2) KRT12-5JI HSH-12-15(2)TR KRT12-5JC



HSH-12-62C(L) KRT12-5JK-L HSH-12-62C(R) KRT12-5JK-R H12-15L KRT842F-S H12-15L(TR2) KRT30JCI H12-15LC KRT845BK H12-15LC(TR2) KRT30JC



HSH-12-15 KRT12-5S HSH-12C KRT12-5MK HSH-11-55 KRT11-5 HSH-12-40 KRT12-4 HSH-12-15MM(V) KRT12-5LMC HSH-12-15MM KRT12-5LM



HSH-12MC KRT12-5LMK HSH-12-15MMJ KRT11-5LJS HSH-12-15MMJ(A) KRT11-5LJR HSH-12MC(1) HSH-12-15MM(5) KRT-LS2-R HSH-12-15MM(A)



HSH-12-15MMB(5) KRT-LS2-S HG12M(BR) KRT872L HG12MC(1) KRT875 HG12MC(1)TR KRT875LKC HSH-12M-82C(L) KRT12-5LJK2-L HSH-12M-82C(R) KRT12-5LJK2-R

HSH-12M-82CTR(L)
KRT12-5LJKC-LHSH-12M-82CTR(R)
KRT12-5LJKC-RH12MC(2)
KRT30LJH12MC(2)TR
KRT30LJC

317419

SHUTTLE
HOOK

6#(L)



7#(L)



7#⊙



10#(L)



10#⊙



2515



83505



125292



GA3-1



SH31



SH180



SH181



SH205



SH210D



SH210E



SH280



SH307



SH311



SH430



SH430-D



SH430-H



HSH-7-3



HAD-204

BOBBIN
CASE

BC-6-5



BC-6-5-NBL



BC-DB1



BC-DB1(G)



BC-DB1-NBL6



BC-DBM(1)



BC-DBM(1)-NBL3



BC-DBM(2)



BC-DBM(2)-NBL1



153758



421326



BC-15-88



BC-31-15



BC-31-20



BC-269



BC-HA1



BC-HA1(L)



BC-LK(B2)



BC-LK(J3)



BC-DBM(Z1)



BC-DBM(Z1)-NBL3



BC-DBM(Z2)



BC-DBM(Z2)-NBL3



BC-DBZ(1)



BC-DBZ(1)-NBL6



BC-DBZ(2)



BC-DBZ(2)-NBL6



BC-DBZ(3)



BC-DBZ(3)-NBL6



BC-PF418



BC-PF9076



BC-PF9076(14)



BC-PF9076(14)-NBCC



BC-PF9076-NBL



BC-PF9076TG



BC-PF9076TG-NBL6 BC-DU211 BC-DU211-NBL BC-DU211NS-4 CP-PF545 CP-PF591



CP-HPF151 CP-PF144TR CP-PF490 CP-PF541 2441035 2951426



CP-M245 CP-M697 CP-12(2) CP-12C CP-12MC CP-62C



CP-G12C CP-G12MC(1) CP-G12MC(1)TR CP-HPF1242 CP-M82C BC-107(2)



BC-107(2)-NBL BC-457 BC-457(NS) BC-457-NBL BC-2280 BC-DP2(3B)



BC-LBH771 BC-LBH771-NBL BC-LBH790 BC-LBH790 BC-PF3114 BC-PF3114-NBL



18676 CS-1720 SCP-545 BC-310A BC-UN639 NS-40



SHUTTLE
ASM&DRIVER

400-11512 152681-001 152682-001 B1812-205-000 B1812-210-D00



B1812-980-0A0 B1812-980-0BB MS01A0120 S55215-001 SA3284-001 HA1-17



400-06573 152677-101ASM B1814-980-000 S55217-201 SA3239-101



BOBBIN

102-31603(1182) 138-12102(1900A) 9033A 9910 18034A



40264A 55623A 55623AS 55623AS深槽 146025-001(814) 159613-001(430)



KNIFE

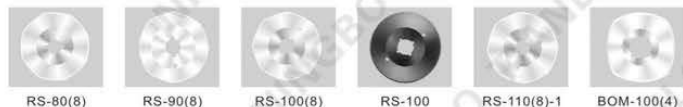

4KM(N) 5KM(N) 6KM(N) 7KM 8KM 9KM 10KM 11KM 12KM 13KM
Alloy steel-HSS

7KMW 8KMW 9KMW 10KMW 11KMW 12KMW 13KMW
Alloy steel-HSS

4E 5E 6E 7E 8E 9E 10E 11E 13E
Alloy steel-HSS

5EW 6EW 7EW 8EW 9EW 10EW 12EW
Alloy steel-HSS

5M 6M 7M 8M 9M 10M 11M 12M 13M
Alloy steel-HSS

5MW 6MW 7MW 8MW 9MW 10MW 11MW 12MW 13MW
Alloy steel-HSS

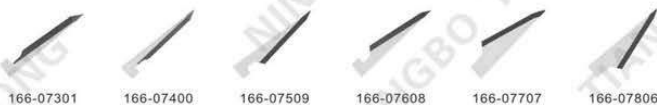
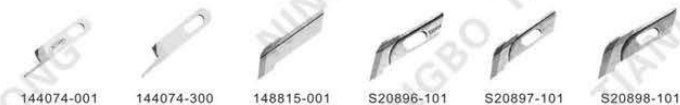



CT290-112 270-113/1 270-113 CT270-113/1 CT290-113 290-113



290-113SP CRL03J CRL04J FR34 FR34B KR35



KR35C KR23 KR23C LU101 LU103 UT506



UT507 MF00A0834 MF00A0838 MF02A0834 MF02A0838 MS03A0838



MS03B0838 S35437-001 10-3072-0-014 10-3072-0-024 558-2562 558-2564



548886 548936 S35092-001(20MM) S37195-001(22MM) S37196-001(24MM) S37197-001(26MM) S37198-001(28MM) S37199-001(30MM) S35093-001(38MM) S37704-001(16MM) S37705-001(18MM) S37706-001(20MM) S37707-001(22MM) S37708-001(24MM) S37709-001(36MM)



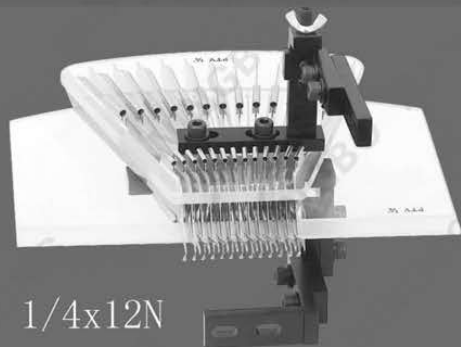

1/4x12N



PTV

1/8×17N 1/4×12N 3/16×12N 3/16×16N 3/16×25N 3/16×33N



GAUGE SET



G801-4, 5, 6(FINE)



G802-4, 5, 6(STANDARD)



G803-4, 5, 6(ROUGH)



APS



SPK-4, 5, 6



SPK-4, 5, 6(W)



珠边机针位

2mm 3mm 4mm 5mm



LH515

1/8 5/32 3/16 7/16 1/4 5/16
3/8 5/8 1/2 3/4 7/8 1"



LT2-B845

1/8 5/32 3/16 7/16 1/4 5/16
3/8 5/8 1/2 3/4 7/8 1"



LT2-B845-UT

1/8 5/32 3/16 7/16 1/4 5/16
3/8 5/8 1/2 3/4 7/8 1"



LT2-B872

1/8 5/32 3/16 7/16 1/4 5/16
3/8 5/8 1/2 3/4 7/8 1"



LT2-B872-UT

1/8 5/32 3/16 7/16 1/4 5/16
3/8 5/8 1/2 3/4 7/8 1"



LT2-B875

1/8 3/16 1/4 5/16 3/8 5/8 1/2
3/4 7/8 1"



LT2-B875-UT

1/8 3/16 1/4 5/16 3/8 5/8 1/2
3/4 7/8 1"



LH-1162

1/8 5/32 3/16 7/16 1/4 5/16
3/8 5/8 1/2 3/4 7/8 1"



MS-1261



MH-380



MH380(2N)



LH-3168-7

1/8 3/16 1/4 5/16
3/8 5/8 1/2 3/4 7/8 1"



LH-3168

1/8 3/16 1/4 5/16
3/8 5/8 1/2 3/4 7/8 1"



LH-21010

1/8 3/16 1/4 5/16
3/8 5/8 1/2 3/4 7/8 1"



MH380(3N)



MH380(3N平行)



DT6-B925



DU-122

1/8 3/16 7/32 1/4 5/16
3/8 5/8 1/2 3/4 7/8 1"



GC-20202

1/8 3/16 7/32 1/4 5/16
3/8 5/8 1/2 3/4 7/8 1"



GUNTING GAUGE SET



DT6-B926



DT6-B926-6A



DT6-926-8AC



MS-19



MS-26



MS-1190



DT6-B927



DT6-B928



DT-B962



SIRUBA 747



PEGASUS W600



PEGASUS L32



JUKI MO-3314



BROTHER B531



YAMATO DCZ-220

1404P/1412P

| 4N | 6N | 10N | 17N |
|-----------|---------|----------|----------|
| 1/8 *4N | 1/8 *6N | 1/8 *10N | 1/8 *17N |
| 3/16*4N | 3/16*6N | 3/16*10N | 18N |
| 1/4 *4N | 1/4 *6N | 1/4 *10N | 1/8 *18N |
| 5/16*4N | 5/16*6N | 11N | 19N |
| 3/8 *4N | 3/8 *6N | 1/8 *11N | 1/8 *19N |
| 7/16*4N | 7/16*6N | 3/16*11N | 21N |
| 1/2 *4N | 8N | 1/4 *11N | 1/8 *21N |
| 9/16*4N | 1/8 *8N | 12N | 23N |
| 5/8 *4N | 3/16*8N | 1/8 *12N | 1/8 *23N |
| 3/4 *4N | 1/4 *8N | 3/16*12N | 25N |
| 1" *4N | 5/16*8N | 1/4 *12N | 1/8 *25N |
| 1-1/8 *4N | 3/8 *8N | 13N | 1/4 *25N |
| 1-3/16*4N | | 1/8 *13N | 27N |
| 1-1/4 *4N | 9N | 3/16*13N | 3/16*27N |
| 1-3/8 *4N | 1/8 *9N | 1/4 *13N | |
| 1-1/2 *4N | 3/16*9N | 15N | 33N |
| 1-3/4 *4N | 1/4 *9N | 1/8 *15N | 1/8 *33N |

VC008

| 4N | 6N | 9N | 13N |
|---------|---------|----------|----------|
| 1/8 *4N | 1/8 *6N | 1/4 *9N | 1/8 *13N |
| 3/16*4N | 3/16*6N | 10N | 3/16*13N |
| 1/4 *4N | 1/4 *6N | 1/8 *10N | 1/4 *13N |
| 5/16*4N | 5/16*6N | 3/16*10N | |
| 3/8 *4N | 3/8 *6N | 1/4 *10N | 1/8 *15N |
| 7/16*4N | 8N | 11N | 17N |
| 1/2 *4N | 1/8 *8N | 1/8 *11N | 1/8 *17N |
| 9/16*4N | 3/16*8N | 12N | 21N |
| 5/8 *4N | 1/4 *8N | 1/8 *12N | 1/8 *21N |
| 3/4 *4N | 5/16*8N | 3/16*12N | 23N |
| 1" *4N | 3/8 *8N | 1/4 *12N | 1/8 *23N |



1412P



VC008

1412PO

| 4N | 6N | 10N | 15N |
|-----------|---------|----------|----------|
| 1/8 *4N | 1/8 *6N | 1/8 *10N | 1/8 *15N |
| 3/16*4N | 3/16*6N | 3/16*10N | 17N |
| 1/4 *4N | 1/4 *6N | 1/4 *10N | 3/16*17N |
| 5/16*4N | 5/16*6N | 11N | 1/8 *17N |
| 3/8 *4N | 3/8 *6N | 1/8 *11N | |
| 7/16*4N | 8N | 12N | 21N |
| 1/2 *4N | 1/8 *8N | 1/8 *12N | 1/8 *21N |
| 9/16*4N | 3/16*8N | 3/16*12N | 23N |
| 5/8 *4N | 1/4 *8N | 1/4 *12N | 1/8 *23N |
| 3/4 *4N | 5/16*8N | 13N | 25N |
| 1" *4N | 3/8 *8N | 1/8 *13N | 1/8 *25N |
| 1-1/4 *4N | 9N | 3/16*13N | |
| 1-1/8 *4N | 1/4 *9N | 1/4 *13N | |

1404PSF (1404WB)

| | | |
|-----------------|-----------|---------------|
| 1/4*1/2*1/4 | 4 needles | total: 1"* |
| 1/4*5/8*1/4 | 4 needles | total: 1-1/8" |
| 1/4*3/4*1/4 | 4 needles | total: 1-1/4" |
| 1/4*7/8*1/4 | 4 needles | total: 1-3/8" |
| 1/4*1" *1/4 | 4 needles | total: 1-1/2" |
| 1/4*1-1/8*1/4 | 4 needles | total: 1-5/8" |
| 1/4*1-1/4" *1/4 | 4 needles | total: 1-3/4" |
| 1/4*1-3/8*1/4 | 4 needles | total: 1-7/8" |
| 1/4*1-5/8" *1/4 | 4 needles | total: 2-1/8" |
| 3/16*5/8*3/16 | 4 needles | total: 1" |
| 3/16*3/4*3/16 | 4 needles | total: 1-1/8" |
| 3/16*7/8*3/16 | 4 needles | total: 1-1/4" |
| 3/16*1" *3/16 | 4 needles | total: 1-3/8" |

1508

| | | |
|-------------------|-----------|----------------|
| 1/4 * 5/8 * 1/4 | 4 needles | total: 1-1/8" |
| 1/4 * 3/4 * 1/4 | 4 needles | total: 1-1/4" |
| 1/4 * 13/16 * 1/4 | 4 needles | total: 1-5/16" |
| 1/4 * 7/8 * 1/4 | 4 needles | total: 1-3/8" |
| 1/4 * 1" * 1/4 | 4 needles | total: 1-1/2" |
| 1/4 * 1-1/8 * 1/4 | 4 needles | total: 1-5/8" |
| 1/4 * 1-1/4 * 1/4 | 4 needles | total: 1-3/4" |
| 1/4 * 1-3/8 * 1/4 | 4 needles | total: 1-7/8" |
| 1/4 * 1-1/2 * 1/4 | 4 needles | total: 2" |
| 3/16 * 1" * 3/16 | 4 needles | total: 1-3/8" |



NEEDLE
PLATE

12422



12438 (W)



12438 (N)



12482



12482LGW



317399



447036



312777



313066



NZ-5LG



NZ-13LG



20160



20160LGB



56065



143169LGB



147150LGB



147150LGW



851112-20



51046000



147158LGW



AB14-AB18



B12-B33



E12-E22



H26(157092)



B1109-012-A00



B1109-012-100



B1109-041-F00



B1109-415-H00



B1109-450-D00



B1109-555-H0B



E701



E702



E704



E704D



E706



E707



E713



E810D



HA1-51



HA1-51LG



HA1-51-1



307



317398

NEEDLE
PLATE
PEGASUS

202546E

202554E
208753204358A 204359A
204366 204367

204368 204369

204528
204529208648 208674
208675277504R30
277504R40
277504R50277505R30
277505R40
277505R50277515R40
277513R40
277513R50277524T50
277524T60277500P30
277500P40
277500P50257015B40
257015B48

257018B56 257018B64

257033B56
257033B64257053B56
257053B64257097B56
257097B64257102B56
257102B64NEEDLE
PLATE
BRTOHER146501-001
146502-001
146503-001146730-001
146731-001
146732-001
146733-001146781-001
146782-001
146783-001S01711-001
S01713-001S19185-001
S19186-001
S19187-001

S20231-001
S20232-001
S20233-001
S25197-001S25190-001
S25191-001S33023-001
S25185-001
S19145-001
S19146-001S08722-001
S08723-001
S08724-001S08733-001
S08734-001
S08735-001S08744-001
S08745-001
S08746-001NEEDLE
PLATE
JUKI

R4205-EOD-EOO



R4305-LOE-EOO

R4612-LOF-GOO
R4612-LOH-GOOR4200-HOD-DAO
R4200-HOD-DOO
R4200-HOE-DOOR4200-JOD-DOO
R4200-JOE-DOO

R4200-JOE-DAO

R4205-HOD-EOO
R4205-HOD-EAOR4305-HOD-EOO
R4305-HOE-EOO
R4305-HOF-EOO

R4305-J6E-EOO

R4305-JOD-EOO
R4305-JOE-EOO
R4305-JOF-EOOR4308-HOD-EOO
R4308-HOF-EOO

R4608-HOF-GOO

R4608-JOD-DOO
R4608-JOE-DOOR4608-JOF-DOA
R4608-JOF-DOO

R4612-HOD-E01

R4612-JOF-DOO
R4612-JOF-DOA

R4612-JOF-GOO

NEEDLE
PLATE
SIRUBA

E206



E208



E224



E229

E1816 E1817
E1826 E1827E1828
E1838
E1848E2626P
E2627PE3326
E3327E3826
E3826PE3827
E3827P

E591

E591A
E591BE591E E591F
E598FE783
E784E804
E805

E809



E868



E919



E919F



E919B

E981 E982
E986E934
E934D

E988

NEEDLE
PLATE
KASAI

14-301



14-760



14-763

14-803
14-804
14-80514-812
14-813

14-818

14-819
14-820

14-854



14-860

14-890
14-89114-896
14-897NEEDLE
PLATE
YAMATOY32666
Y32667Y32670 Y32671
Y32673

Y33353

Y33541
Y33543

Y33545



Y210805



Y2108000

Y2108004
Y2108005

Y95085



Y3118025

Y95278
Y95279

Y94800 Y94801
Y94802Y3208093
Y3208094Y3208096
Y3208097Y95260
Y95261

Y3108134



Y3118023

NEEDLE
PLATE
RIMOLDI202504-0-10
202507-0-11
202448-0-10
202590-0-10

203219-0-11



203354-4-12



203583-0-11



204026-0-11

302467-0-10
302416-0-10302735-0-10
302735-0-13NEEDLE
PLATE
SPECIAL

144635-001



145246-001



B2402-761-000



B2402-762-000



B2402-771-000



S10570-001



s10572-001



S10573-001



S10574-001



B1190-522-V00



B1190-522-Y00



B1190-522-T00



B1190-522-S00



B1190-522-U00



B1190-530-F00



B1190-530-D00



B1190-530-H00

FEED
DOG

149057D



111860-001



SA2345-001



149165



149159



149057TR



149057R



149057



149057(fine)



2441035



147315-001



143174



59816



S03885-001



D701



B1613-555-H00



B1613-450-D00



B1613-012-I00



B1609-415-HOB



B1609-415-BOO



B1609-041-FOO



275010



272153



150793



149062



44



12369



12481(9T-21T)



12481(fine)



12481D



12481R



12481TR



26603



99601



A10



B1613-012-A00 B1613-012-NOO B1613-522-N00 B1613-522-W00 12436 18031



26270 46398 446017 531667 R28(HA1-77) HA1-77-1



JH-307-1 JH-307 JH-717 JH-811 210518 417920



503683 503734 503734N 503743 541647 541734

**FEED
DOG
PEGASUS**



201097C 202854A 204676 204730 277304-16F
201094B 20194B 208078 208090 277302-16F



277323 277327-16F 210442 210494 210501 210497
277325 277329-16F 210569 210581 210582 210581



277303-16F 208215 208217 208218 257143 257242-16F
277305-16F 208063 208064 208065 257290 257289-16F



257245-16F 257258 257260-16F 257261-16F 257268-16F 259101-16F
257292-16F 257206 257214-16F 257215-16F 257222-16F 259203-16F



259103-16F 257255-16F 259218-16F 257262-16F 257267-16F 257268-16F
259215-16F 257202-16F 259106-16F 257216-16F 257221-16F 257222-16F



259202-16F 257290-16F 257222-16F
259100-16F 257243-16F 257268-16F

**FEED
DOG
SIRUBA**



H442 D569 H442 D290 H445 D574 H445 D575 H494 D581



H497 D498 H497 D581 H500 D581 H501 D582 H859 D996 H957 D002



H974 D969 H1258 D1206 H1261 D1215 H1282 D1216 H3362 D3216 H4258 D4206

**FEED
DOG
YAMATO**

21842 90624 2108050 2109000 2109050
21846 90625 2108051 2109001 2109051



3509036 6509012 3209012 Y93394 3109000
3509037 6509002 3209013 Y93395 3109001
6509022



3109002 3159034 3209002 3509004 3209003 3209008
3109003 3159037 3209003 3509005 3209008 3209009



3209065 Y93412 Y95087 Y95263
3209064 3509000 Y93411 Y94233 Y94593
3509001 3509005

**FEED
DOG
KANSAI**

15-361 15-753 15-753 15-755 15-756
15-301 15-723 15-723 15-724 15-727



15-758 15-805 15-806 15-811
12-729 15-806 15-805 15-812

**NEEDLE
CLAMP
PEGASUS**

208905 209670 211358 211360 257501-64 277517-48



277518-56 208909 208954 208965 179630 277022

**NEEDLE
CLAMP
BROTHER**

146487-001 181008-001 181079-001 181716-001 183954-001 S08701-001



S08709-001 S08711-001 S08713-001 S20404-001 S20398-001 146773-001

**NEEDLE
CLAMP
JUKI**

118-69005 118-69658 124-65001 124-65100 121-48607 121-48706



122-56905 121-50702 121-50306 121-50603 124-65407 118-70755 118-70359

NEEDLE CLAMP SIRUBA



KG131 KG142 KG153 KG155 KG333 KG355



M4248 M4356 M4364

NEEDLE CLAMP YAMATO



Y93257 Y93353 Y93357 Y2109100 Y2109101 Y2109102



Y2109110 Y2109120 Y2109130 Y2109132 Y3209102 Y3209107

NEEDLE CLAMP KASAI



12-229 12-828 12-839 12-802 12-812 12-702

NEEDLE CLAMP KINGTEX



NCC00400 NCC00561 NCC00641 NC603033 NC604022 NC605048

NEEDLE CLAMP SHING LING



FC240 FC248 FC356 FC364 FC464

PRESSER FOOT



CRE
CR1/02E (21R)
CR1/16E (21I)
CR3/02E (21I-1/2)
CR1/16E (21Z)
CR5/02E (21A-1/2)
CR3/16E (21Z)
CR1/4E (21A)
CR5/16E (215R)
CR3/8E (216R)
CR1/2E (218R)

CLE
CL1/02E (22L)
CL1/16E (22I)
CL3/02E (22I-1/2)
CL1/8E (22Z)
CL5/02E (22Z-1/2)
CL3/16E (22Z)
CL1/4E (22A)
CL5/16E (225L)
CL3/8E (226L)
CL1/2E (228L)

211-15
211-13 (116X/16)
211-14 (116X/14)
211-15 (116X/15)
211-16 (116X/16)
211-17 (116X/17)
211-18 (116X/18)
211-19 (116X/19)



CR
CR1/32N
CR1/16N
CR1/32
CR1/16
CR3/32
CR1/8
CR5/32
CR3/16
CR1/4
CR5/16
CR3/8
CR1/2

CL
CL1/32N
CL1/16N
CL1/32
CL1/16
CL3/32
CL1/8
CL5/32
CL3/16
CL1/4
CL5/16
CL3/8
CL1/2

CD
CDH-002/00
CD-002/3
CD-10-1.0mm
CD-15-1.5mm
CD-20-2.0mm
CDH-132/02/04
CDH-116/03/10
CD-116/02/31
CD-18/02/32
CD-31/02/33
CD-31/4/02/34



2314-24
2314-24 (1/32X1/4)
2311-14-24 (1/16X1/4)
23-15-25
23-15-25 (1/32X5/16)
2311-15-25 (1/16X5/16)

CR15N
CR-10N-1.0mm
CR-15N-1.5mm
CR-10-1.0mm
CR-15-1.5mm
CR-20-2.0mm
CR-25-2.5mm
CR-30-3.0mm
CR-40-4.0mm

CL15N
CL-10N-1.0mm
CL-15N-1.5mm
CL-10-1.0mm
CL-15-1.5mm
CL-20-2.0mm
CL-25-2.5mm
CL-30-3.0mm
CL-40-4.0mm



CRK
CR1/32NK (CR08NK)
CR1/16NK (CR15NK)
CR1/32K (CR08K)
CR1/16K (CR15K)
CR3/32K (CR25K)
CR1/8K (CR30K)
CR3/16K (CR50K)
CR1/4K (CR65K)
CR5/16K (CR80K)
CR3/8K (CR100K)
CR1/2K (CR130K)

CLK
CL1/32NK (CL08NK)
CL1/16NK (CL15NK)
CL1/32K (CL08K)
CL1/16K (CL15K)
CL3/32K (CL25K)
CL1/8K (CL30K)
CL5/32K (CL40K)
CL3/16K (CL50K)
CL1/4K (CL65K)
CL5/16K (CL80K)
CL3/8K (CL100K)
CL1/2K (CL130K)

NR-31S
NL-31S



CRNS
CR1/32NS
CR1/16NS

CLNS
CL1/32NS
CL1/16NS

12435R
12435R-1/8 (P31C-1/8)
12435R-3/16 (P31C-3/16)
12435R-1/4 (P31C-1/4)

31358L
31358L-1/8 (P301C-1/8)
31358L-3/16 (P301C-3/16)
31358L-1/4 (P301C-1/4)



**PRESSER
FOOT
PEGASUS**

201152E-201155C 201152E-205525 201230G-210374 208730 208501



277118 208502 208504 208508 208955 257321A56



257461-48 257468-48 257472-48 257490

**PRESSER
FOOT
JUKI**

118-76158 118-76869 118-77750 118-81455 118-81554



121-52468 118-77552 121-53755 121-53763 121-54266 124-70050

**PRESSER
FOOT
SIRUBA**

P253/F374 P253/F371 P253/F525 P103/F374 P152-F155



P255



P500



P501



P502



P504



P508



P955



P1406



P0216



P0217



P2117



P2408

PRESSER
FOOT
BROTHER

S19255-001



S19262-001



S19282-001



S19291-001



S19260-001



S19280-001



146904-001



148013-001



146871-001



S19313-201



146902-001

PRESSER
FOOT
KASAI

17-301



17-361



17-712



17-769



17-843



17-856



17-886



17-889



17-760

PRESSER
FOOT
YAMATO

32343



32750



64041-N



3507052



95587



Y3117124



92115



Y3507064



Y95316



95316



64042

PRESSER
FOOT
SPECIAL

U192



U193



U193-1



U192T



U193T

U192B U193SS
1/16 3/32 1/8 5/32
3/16 1/4

U192H



U193K



U192L



U192K



U193K

U192R U193SS
1/16 3/32 1/8 5/32
3/16 1/4

U193R



U192Y



U193Y



10795V



10796D

10795V 10796D
1/8 3/16 1/4

10795



10796L



10796T



10795V



10796D

10795V 10796K
1/8 5/32 3/16 5/16
1/4 3/8S30 S31
1/8 3/16 1/4 3/8
1/2 5/8 3/4S583L S584L
1/8 3/16 5/32
1/4 5/16S583 S584
1/8 3/16 5/32
1/4 5/16S68
1/8 3/16 1/4 5/16
3/8 1/240474 40475
3MM 4MM 5MM

TEFLON
PRESSER
FOOT

TCL

TCL 1/32 N TCL 5/32
TCL 1/16 N TCL 3/16
TCL 1/32 TCL 1/4
TCL 1/16 TCL 5/16
TCL 1/8 TCL 1/2
TCL 3/32



TCR

TCR 1/32 N TCR 5/32
TCR 1/16 N TCR 3/16
TCR 1/32 TCR 1/4
TCR 1/16 TCR 5/16
TCR 1/8 TCR 1/2
TCR 3/32



MT-18



T35C

T35C-11 MM
T35C-12.5 MM
T35C-15 MM
T35C-20 MM
T35C-25 MM
T35C-30 MM
T35C-35 MM



T35



T35-11 MM
T35W-12.5 MM
T35W-15 MM



MT-260

MT-260 1/8
MT-260 3/16
MT-260 5/16
MT-260 3/8
MT-260 1/2
MT-260 3/4
MT-260 1"



T69L 1/8
T69L 3/16
T69L 1/4



T69R 1/8
T69R 3/16
T69R 1/4



MTA-12.5MM
MTA-16MM



MTA-12.5MM
MTA-14MM
MTA-16MM
(hole)



T351-11MM
T351-12.5MM



T350



T811
T812
T813
T814
T815



T36



T36L



T36LN



T36N



T363



MT-1



T107-9MM
T107-12MM



T652-9MM
T652-12MM



S518N-T



S28T-4.0
S28T-4.8
S28T-5.6



TFR-12



YKK



F4=0.5MM
F4=0.8MM
F4=1.0MM
F4=1.5MM



903UL



B1511-761-0B0



B1511-762-0B0



B1511-763-0B0



B1511-771-0A0



B1511-772-0A0



B1511-773-0B0



144497-001



144574-001



145145-001



S37101-102



S37102-101



145-23252ASM



150763-001



150764-001



150765-001



400-06342ASM

FEED PLATE & WORK CLAMP-430



FEED PLATE & WORK CLAMP-430D

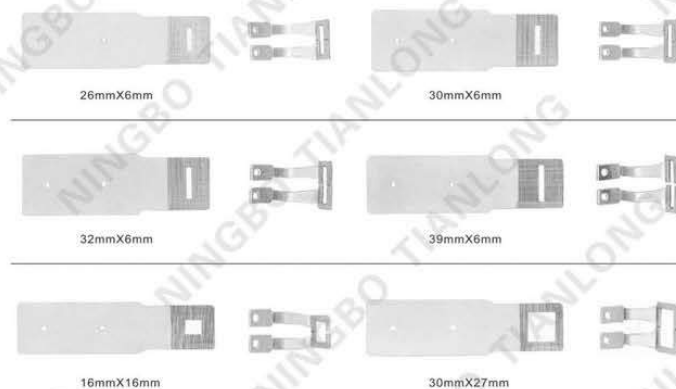

FEED PLATE & WORK CLAMP-1900

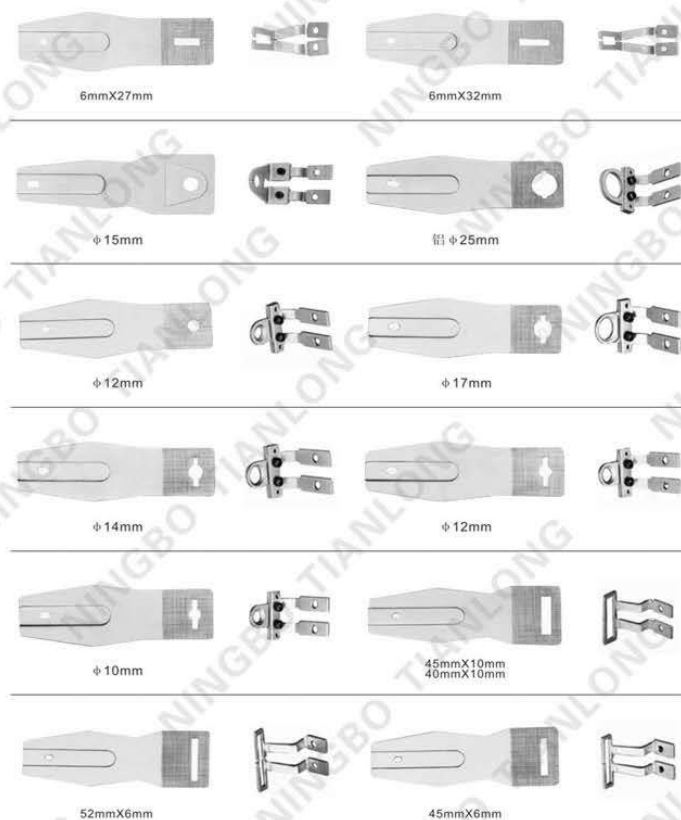

FEED PLATE & WORK CLAMP-1900



39mmX6mm



32mmX6mm



27mmX6mm



26mmX6mm



FEED PLATE & WORK CLAMP-1850



25mmX10mm



25mmX6mm



FEED PLATE & WORK CLAMP-1201



40mmX20mm



32mmX12mm



39mmX8mm



20mmX4mm



φ12mm φ15mm



NEEDLE BAR & PRESSER BAR



810



271



820



BROTHER 101



335(PF)



BROTHER 551



8810



GC 6-7



1850



BROTHER N31



814(PF)



515



YAMATO2500



522(PF)



W500



3168



W600



845



F007



5550(PF)



EMBROIDERY



JUKI MO-3316



1162(PF)



KASAI 1404



20U



3168(PF)



781



M600



5550



M700



373



5550(ALUMINUM)

**LOOPER
PEGASUS**

257567-1



204278 (1#)



204704 (3#)



204705 (5#)



211845 (29#)



210512 (21#)



210514 (25#)



210523 (23#)



204062 (2#)



204703



204949



277010 (2#)



277010A (5#)



277010B (6#)



277011 (3#)



204663 (7#)



204963 (8#)



204990 (12#)



210360



206097A



257550



257555



257552



257565



257566



210356



277015



277018



277034



202703



204072



204431



209685



204314A



257551



210357



137301



137302

**LOOPER
SIRUBA**

LP21



LP23



LP24



LP26



LP36



LP38



A300



KG31



KG37



KG59



KG471



ME67



MT01



MU06



VE30Q



VE49



VE51



KL25



KL35



kl65



KL202



KM04



MH41



ME28



FS03



FS04



HE21



HE22

**LOOPER
JUKI**

118-88005 (80#)



118-88104 (81#)



118-88203 (82#)



118-88302 (83#)



119-91403



119-99208 (92#)



121-76004 (60#)



121-76103 (61#)



B2514-803-000



B2519-804-000



B2519-814-000





146635-001



146726-001

**LOOPER
YAMATO**

2109320



2109322



6209302



6209304



Y32539



2109324



21701



31261



32415



32416



6209301



34392



34393



35253



35254



3209311



Y94480



68217



6509300



3109300



90425



3109310



3209300

**LOOPER
KASAI**

19-431(3.2MM)



19-431A(2.5MM)



19-431N(2.7MM)



19-431S(2.3MM)



19-525



19-112



19-512



19-518



19-531



19-535



19-536



19-539



19-712



19-713



19-801



19-811



19-581



19-582



19-751



19-807



19-505



19-416



19-437

**LOOPER
SINGER**

139056



139057



410262



370236



400041



410434



410452



543232



548205



548207



548231



175085



213826



268382

**LOOPER
RIMOLDI**

209248-0-00



209249-0-00



211248-0-00



351161-0-10



202092-0-10



204022-0-10



208011-0-10



202094-0-10



202094-0-11



204675-0-10



204676-0-10



209264-0-00



209265-0-00



202413-0-00

LOOPER
DURKOPP

557-602A



557-605



557-611



557-614

LOOPER
REECE

D4



D5



D6



D7



D8



D9

LOOPER
PFAFF

91-169747-05



91-169747-05



91-170966-05



91-176980-05



91-176981-05



91-172797-05



91-176055-91



91-169877-05



91-169990-05



91-176982-05



96-722820-05



96-795104-00

10313
H10801LOOPER
UNION
SPECIAL

2108A



33709A



35808AY



35809AY



35809BY



39508A



39508B



39808A



50309K



51108DA



51108D



51108E



51409B



51409C



51708



51709



51908B-9



51909C



51909D-9



52708A



52708B



36251F

LOOPER
OTHERS

36-16



36C22-1



2200



4039



11837



80412



187053



B4815-640-000



410434



36-19



36-21



GC6-1

TENSION
SET

HA1-93



HA1-93AD



5550



Br735



555



GC6-1



6-1 NEW



SINGER



SUNSTAR



20U



0318



430D



2284



781-1



781



1404-1



1850



M600



8B(1N)



8B(2N)



335



474-1



474-2



515



820



842



845-A



845-B



1162



3128



3168



BR831



8820



8810



810



1508



VC008



457



C007(B)



C007(A)



1900A



12N



F007



12N-1



W500



24N



842

3168

430

430D

800A

735



7200

555

5550

1850

1900A

1903



781

335

20U

591

652

820



8810

9900

GC6-1

GC6-5

0302

SUNSTAR



91-118 099-91



91-138 513-91



91-500 250-71



41-101A-120H



TYPICAL 6180



141-13666



400-23021



282173-451



JUKI 8800



SA1971-101



SIRUBA AKU27



PEGASUS M600



KINGTEX SH7000-4



JUKI 2514



JUKI 2516



SIRUBA 757



PEGASUS M700



KINGTEX SH7000-5



SIRUBA 747



SIRUBA 757



SIRUBA KU60-A



PEGASUS L52



AP11E



G9E



G900E



SC735



YS4454

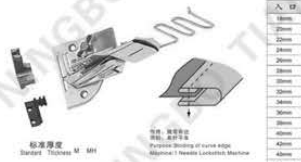
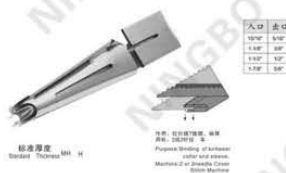
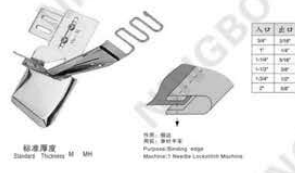
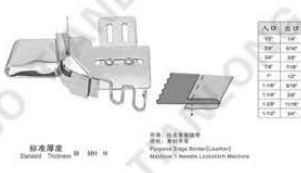

YS4455

TL-113 翻边与直角包边机 (平口单边包边机可用)
Right Angle Binder For Seam WearTL-114 翻边与直角包边机 (平口单边包边机可用)
Right Angle Binder For Seam WearTL-119 A10/S60 平头直角包边器
Right Angle Book BinderTL-120 K10 平头直角包边器
Right Angle Book BinderTL-115 翻边器
Right Angle BinderTL-116 翻边器
Right Angle BinderTL-121 A4/100 翻边器
Edge BinderTL-122 A118 平头直角包边器
Right Angle Book BinderTL-117 翻边与直角包边机 (平头单边包边机可用)
Right Angle BinderTL-118 翻边与直角包边机 (平头单边包边机可用)
Right Angle BinderTL-123 A9/S08 翻边包边器
Plain Book BinderTL-124 翻边包边器
Board of Page Binder

TL-125

斜口包边器 (平车用)
Right Angle Bias Binder



| 入口 | 出口 |
|-------|-------|
| 10mm | 10mm |
| 15mm | 15mm |
| 20mm | 20mm |
| 25mm | 25mm |
| 30mm | 30mm |
| 35mm | 35mm |
| 40mm | 40mm |
| 45mm | 45mm |
| 50mm | 50mm |
| 55mm | 55mm |
| 60mm | 60mm |
| 65mm | 65mm |
| 70mm | 70mm |
| 75mm | 75mm |
| 80mm | 80mm |
| 85mm | 85mm |
| 90mm | 90mm |
| 95mm | 95mm |
| 100mm | 100mm |

标准厚度
Standard Thickness: 10-110

适用: 普通平车
适用: 普通平车
Purpose: Binding of furrow edge
Machine: 1 Needle Lockstitch Machine

TL-126

平车斜角包边器 (斜口)
Right Angle Bias Binder

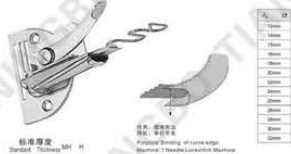

| 入口 | 出口 |
|-------|-------|
| 10mm | 10mm |
| 15mm | 15mm |
| 20mm | 20mm |
| 25mm | 25mm |
| 30mm | 30mm |
| 35mm | 35mm |
| 40mm | 40mm |
| 45mm | 45mm |
| 50mm | 50mm |
| 55mm | 55mm |
| 60mm | 60mm |
| 65mm | 65mm |
| 70mm | 70mm |
| 75mm | 75mm |
| 80mm | 80mm |
| 85mm | 85mm |
| 90mm | 90mm |
| 95mm | 95mm |
| 100mm | 100mm |

标准厚度
Standard Thickness: 10-110

适用: 普通平车
适用: 普通平车
Purpose: Binding of furrow edge
Machine: 1 Needle Lockstitch Machine

TL-131

斜角包边器包边器
Edge Binder for Pegator Overlock Machine



| 入口 | 出口 |
|------|------|
| 20mm | 20mm |
| 25mm | 25mm |
| 30mm | 30mm |
| 35mm | 35mm |

标准厚度
Standard Thickness: M

适用: 普通平车
适用: 普通平车

TL-133 (F516)

斜口封边器
Loop Folder



| 入口 | 出口 |
|---------|---------|
| 33" | 33" |
| 31 1/2" | 31 1/2" |
| 1" | 1" |
| 5 1/4" | 5 1/4" |
| 1 1/2" | 3 1/8" |

标准厚度
Standard Thickness: 10-110

适用: 普通平车
适用: 普通平车
Purpose: Loop and sewing
Machine: 1 Needle Lockstitch Machine

TL-127 (F219)

包边器
Shaver Packlet Binder

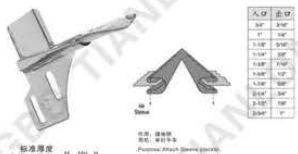

| 入口 | 出口 |
|--------|--------|
| 3 1/2" | 3 1/2" |
| 1" | 1" |
| 1 1/4" | 1 1/4" |
| 1 3/8" | 1 3/8" |
| 1 1/2" | 1 1/2" |
| 1 3/4" | 1 3/4" |
| 1 7/8" | 1 7/8" |
| 2" | 2" |
| 2 1/4" | 2 1/4" |
| 2 1/2" | 2 1/2" |
| 2 3/4" | 2 3/4" |
| 3" | 3" |

标准厚度
Standard Thickness: M-110

适用: 普通平车
适用: 普通平车
Machine: 1 Needle Lockstitch Machine

TL-128

斜角封边器
Bias Folder



| 入口 | 出口 |
|-----|-----|
| 10" | 10" |
| 11" | 11" |
| 12" | 12" |
| 13" | 13" |
| 14" | 14" |
| 15" | 15" |
| 16" | 16" |
| 17" | 17" |
| 18" | 18" |
| 19" | 19" |
| 20" | 20" |
| 21" | 21" |
| 22" | 22" |
| 23" | 23" |
| 24" | 24" |
| 25" | 25" |

标准厚度
Standard Thickness: M-110

适用: 普通平车
适用: 普通平车
Machine: 1 Needle Lockstitch Machine

TL-134 (F515)

平车斜角封边器
Loop Folder Foot



| 入口 | 出口 |
|-----|-----|
| 10" | 10" |
| 11" | 11" |
| 12" | 12" |
| 13" | 13" |
| 14" | 14" |
| 15" | 15" |
| 16" | 16" |
| 17" | 17" |
| 18" | 18" |
| 19" | 19" |
| 20" | 20" |
| 21" | 21" |
| 22" | 22" |
| 23" | 23" |
| 24" | 24" |
| 25" | 25" |

标准厚度
Standard Thickness: M-110

适用: 普通平车
适用: 普通平车
Machine: 1 Needle Lockstitch Machine

TL-135 (AT8)

平车包边器 (斜口)
Edge Binder for Single Needle Machine



| 入口 | 出口 |
|-------|-------|
| 10mm | 10mm |
| 15mm | 15mm |
| 20mm | 20mm |
| 25mm | 25mm |
| 30mm | 30mm |
| 35mm | 35mm |
| 40mm | 40mm |
| 45mm | 45mm |
| 50mm | 50mm |
| 55mm | 55mm |
| 60mm | 60mm |
| 65mm | 65mm |
| 70mm | 70mm |
| 75mm | 75mm |
| 80mm | 80mm |
| 85mm | 85mm |
| 90mm | 90mm |
| 95mm | 95mm |
| 100mm | 100mm |

标准厚度
Standard Thickness: M

适用: 普通平车
适用: 普通平车
Machine: 1 Needle Lockstitch Machine

TL-129

平车斜角包边器
Edge Binder for Pegator Overlock Machine

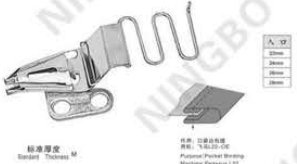

| 入口 | 出口 |
|-------|-------|
| 10mm | 10mm |
| 15mm | 15mm |
| 20mm | 20mm |
| 25mm | 25mm |
| 30mm | 30mm |
| 35mm | 35mm |
| 40mm | 40mm |
| 45mm | 45mm |
| 50mm | 50mm |
| 55mm | 55mm |
| 60mm | 60mm |
| 65mm | 65mm |
| 70mm | 70mm |
| 75mm | 75mm |
| 80mm | 80mm |
| 85mm | 85mm |
| 90mm | 90mm |
| 95mm | 95mm |
| 100mm | 100mm |

标准厚度
Standard Thickness: M

适用: 普通平车
适用: 普通平车
Machine: Paper-L22

TL-130

斜角包边器包边器 (斜口)
Edge Binder for JUKI Overlock Machine



| 入口 | 出口 |
|-------|-------|
| 10mm | 10mm |
| 15mm | 15mm |
| 20mm | 20mm |
| 25mm | 25mm |
| 30mm | 30mm |
| 35mm | 35mm |
| 40mm | 40mm |
| 45mm | 45mm |
| 50mm | 50mm |
| 55mm | 55mm |
| 60mm | 60mm |
| 65mm | 65mm |
| 70mm | 70mm |
| 75mm | 75mm |
| 80mm | 80mm |
| 85mm | 85mm |
| 90mm | 90mm |
| 95mm | 95mm |
| 100mm | 100mm |

标准厚度
Standard Thickness: M

适用: 普通平车
适用: 普通平车

TL-136 (AT8)

平车包边器包边器 (斜角包边)
Edge Binder for Single Needle Machine



| 入口 | 出口 |
|------|------|
| 12mm | 12mm |
| 14mm | 14mm |
| 16mm | 16mm |
| 18mm | 18mm |
| 20mm | 20mm |
| 22mm | 22mm |
| 24mm | 24mm |
| 26mm | 26mm |
| 28mm | 28mm |
| 30mm | 30mm |

标准厚度
Standard Thickness: M

适用: 普通平车
适用: 普通平车
Machine: 1 Needle Lockstitch Machine

TL-137 (AT8)

平车包边器包边器 (斜角)
Edge Binder for Single Needle Machine



| 入口 | 出口 |
|------|------|
| 12mm | 12mm |
| 14mm | 14mm |
| 16mm | 16mm |
| 18mm | 18mm |
| 20mm | 20mm |
| 22mm | 22mm |
| 24mm | 24mm |
| 26mm | 26mm |
| 28mm | 28mm |
| 30mm | 30mm |

标准厚度
Standard Thickness: M

适用: 普通平车
适用: 普通平车
Machine: 1 Needle Lockstitch Machine

TL-138 (335)

脚踏式压圈机
Brail of Small-sized Cylinder Bead Machine标准厚度
Standard Thickness M H H脚踏式压圈机
Machine Cylinder-Bead Machine

| 入口 |
|------|
| 12mm |
| 13mm |
| 14mm |
| 15mm |
| 16mm |
| 18mm |
| 20mm |
| 22mm |
| 24mm |
| 26mm |
| 28mm |

TL-139 (335)

脚踏式压圈机
Edge Brider for Single Needle Machine标准厚度
Standard Thickness M H H脚踏式压圈机
Machine Cylinder-Bead Machine

| 入口 |
|------|
| 12mm |
| 18mm |
| 20mm |
| 24mm |
| 26mm |
| 28mm |

TL-140 (335)

脚踏式压圈机
Brider for Small-sized Cylinder Bead Machine标准厚度
Standard Thickness M H H脚踏式压圈机
Machine Cylinder-Bead Machine

| 入口 |
|------|
| 18mm |
| 20mm |
| 22mm |
| 24mm |
| 26mm |
| 28mm |
| 30mm |

TL-141 (F301)

压头器
Wrist Band Folder标准厚度
Standard Thickness M H H脚踏式压圈机
Machine 2,3,4 Needle Elastic Machine

| 入口 | 出口 |
|------|------|
| 2.5" | 2" |
| 3" | 1.5" |
| 3.5" | 1.5" |
| 3.5" | 1.5" |
| 3.5" | 1.5" |
| 3.5" | 1.5" |
| 4" | 1.5" |
| 4.5" | 1.5" |
| 4.5" | 2" |

TL-142 (F302)

压头器
Wrist Band Folder标准厚度
Standard Thickness M H H脚踏式压圈机
Machine 2,3,4 Needle Elastic Machine

| 入口 | 出口 |
|------|------|
| 2.5" | 2" |
| 3" | 1.5" |
| 3.5" | 1.5" |
| 3.5" | 1.5" |
| 3.5" | 1.5" |
| 4" | 1.5" |
| 4.5" | 1.5" |
| 4.5" | 2" |

TL-143 (F303)

压头器
Wrist Band Folder标准厚度
Standard Thickness M H H脚踏式压圈机
Machine 2,3,4 Needle Elastic Machine

| 入口 | 出口 |
|------|------|
| 2.5" | 2" |
| 3" | 1.5" |
| 3.5" | 1.5" |
| 3.5" | 1.5" |
| 3.5" | 1.5" |
| 4" | 1.5" |
| 4.5" | 1.5" |
| 4.5" | 2" |

TL-144 (F304)

脚踏式压圈机
Wrist Band Folder with Lining标准厚度
Standard Thickness M H H脚踏式压圈机
Machine 2,3,4 Needle Elastic Machine

| 入口 | 出口 |
|------|------|
| 2.5" | 2" |
| 3" | 1.5" |
| 3.5" | 1.5" |
| 3.5" | 1.5" |
| 3.5" | 1.5" |
| 4" | 1.5" |
| 4.5" | 1.5" |
| 4.5" | 2" |

TL-145

脚踏式压圈机
Edge Brider (Zigzag Sewing)标准厚度
Standard Thickness M H H脚踏式压圈机
Machine Zigzag Needle Plate

| 入口 | 出口 |
|-----|-----|
| 12" | 10" |
| 14" | 10" |

TL-146

脚踏式压圈机
Edge Brider (Zigzag Sewing)标准厚度
Standard Thickness M H H脚踏式压圈机
Machine Zigzag Needle Plate

| 入口 | 出口 |
|-----|-----|
| 12" | 10" |
| 14" | 10" |

TL-147

脚踏式压圈机
Edge Brider (Zigzag Sewing)标准厚度
Standard Thickness M H H脚踏式压圈机
Machine Zigzag Needle Plate

| 入口 | 出口 |
|-----|-----|
| 12" | 10" |
| 14" | 10" |

TL-155

压头器
Wrist Band Folder标准厚度
Standard Thickness M H H脚踏式压圈机
Machine 2,3,4 Needle Elastic Machine

| 入口 | 出口 |
|------|------|
| 2.5" | 2" |
| 3" | 1.5" |
| 3.5" | 1.5" |
| 3.5" | 1.5" |
| 3.5" | 1.5" |
| 4" | 1.5" |
| 4.5" | 1.5" |
| 4.5" | 2" |

TL-143 (F303)

压头器
Wrist Band Folder标准厚度
Standard Thickness M H H脚踏式压圈机
Machine 2,3,4 Needle Elastic Machine

| 入口 | 出口 |
|------|------|
| 2.5" | 2" |
| 3" | 1.5" |
| 3.5" | 1.5" |
| 3.5" | 1.5" |
| 3.5" | 1.5" |
| 4" | 1.5" |
| 4.5" | 1.5" |
| 4.5" | 2" |

TL-155

压头器
Wrist Band Folder标准厚度
Standard Thickness M H H脚踏式压圈机
Machine Zigzag Needle Plate

| 入口 | 出口 |
|------|------|
| 2.5" | 2" |
| 3" | 1.5" |
| 3.5" | 1.5" |
| 3.5" | 1.5" |
| 3.5" | 1.5" |
| 4" | 1.5" |
| 4.5" | 1.5" |
| 4.5" | 2" |

TL-156 F306

压头器
Wrist Band Folder标准厚度
Standard Thickness H H H脚踏式压圈机
Machine Zigzag Needle Plate

| 入口 | 出口 |
|------|------|
| 3" | 1.5" |
| 3.5" | 1.5" |
| 3.5" | 1.5" |
| 3.5" | 1.5" |
| 4" | 1.5" |
| 4.5" | 1.5" |
| 4.5" | 2" |

TL-157 F220

翻车包边机
Packer Binder with Piping



| 入口 | 出口 |
|------|------|
| 2.5" | 1" |
| 3.5" | 1.5" |
| 5.5" | 2.5" |
| 7" | 3" |
| 8.5" | 3.5" |
| 10" | 4" |

用途: 压边包边
用途: 压边包边
Purpose: Bind edge machine. Packer
bind and seal book with piping.
Machine: 1 Needs Lockstitch machine

标准厚度
Standard Thickness: M, SH

TL-160 F536

厚料直角包边机 (出口)
Right Angle Bias Binder



| 入口 |
|------|
| 12mm |
| 14mm |
| 16mm |
| 18mm |
| 20mm |
| 22mm |
| 24mm |
| 26mm |
| 28mm |
| 30mm |
| 32mm |

用途: 压边包边
用途: 压边包边
Purpose: Binding of cross edge
Machine: 1 Needs Lockstitch machine

标准厚度
Standard Thickness: H, SH

TL-168 A9(508)

翻车包边机 (出口)
Puan Book Binder



| 入口 |
|-------|
| 3.5" |
| 4.5" |
| 5.5" |
| 6.5" |
| 7.5" |
| 8.5" |
| 9.5" |
| 10.5" |
| 11.5" |
| 12.5" |
| 13.5" |

用途: 压边包边
用途: 压边包边
Purpose: Binding edge
Machine: 1 Needs Lockstitch machine

标准厚度
Standard Thickness: M, SH

TL-201 A75U

翻车包边机
Single Up Turn Folder



| 规格 |
|--------|
| 5 1/2" |
| 5 1/4" |
| 5 1/8" |
| 5 3/8" |
| 5 7/8" |
| 6 1/4" |
| 6 3/8" |
| 6 7/8" |
| 7" |

用途: 翻车上折包边
用途: 翻车上折包边
Purpose: Single up turn binding of general purpose
Machine: 1 Needs Lockstitch machine

标准厚度
Standard Thickness: M, SH, H

TL-161

平车直角包边机 (出口)
Right Angle Bias Binder



| 入口 |
|------|
| 18mm |
| 20mm |
| 22mm |
| 24mm |
| 26mm |
| 28mm |
| 30mm |
| 32mm |

用途: 压边包边
用途: 压边包边
Purpose: Binding of cross edge
Machine: 1 Needs Lockstitch machine

标准厚度
Standard Thickness: M

TL-162

平车直角包边机 (出口)
Right Angle Bias Binder



| 入口 |
|------|
| 12mm |
| 14mm |
| 16mm |
| 18mm |
| 20mm |
| 22mm |
| 24mm |
| 26mm |

用途: 压边包边
用途: 压边包边
Purpose: Binding of cross edge and spine (2000L)
Machine: 2 Needs Cover Stitch Machine

标准厚度
Standard Thickness: M, SH, H

TL-202 U12

折边器
Turn Page Hammer



| 规格 |
|-------|
| 2.5x3 |
| 3x3.5 |
| 4x3 |

用途: 折边
用途: 折边
Purpose: Straighten Edge Hammer
Machine: 1 Needs Lockstitch machine

标准厚度
Standard Thickness: M

TL-203 A11/S72L

折边器
Binding Hammer



| 规格 |
|--------|
| 1 1/2" |
| 1 3/4" |
| 1 7/8" |
| 2" |
| 2 1/8" |
| 2 1/4" |
| 2 3/8" |
| 2 1/2" |
| 2 5/8" |
| 3" |
| 3 1/8" |
| 3 1/4" |
| 3 3/8" |
| 3 1/2" |
| 3 5/8" |
| 4" |

用途: 折边
用途: 折边
Purpose: General straight binding
Machine: 1 Needs Lockstitch machine

标准厚度
Standard Thickness: M, SH, H

TL-163

翻车包边器
Bookcase Edge Binder



| 出口 |
|-------|
| 5.2mm |
| 6.4mm |
| 8mm |

用途: 压边包边
用途: 压边包边
Purpose: Cover end and of water bar with stitching
Machine: Single Water Bar Machine

标准厚度
Standard Thickness: M, SH, H

TL-167

压边器
Water Bar Folder



| 入口 | 出口 |
|------|-------|
| 12mm | 5.2mm |
| 14mm | 5.2mm |
| 16mm | 5.2mm |
| 18mm | 5.2mm |
| 20mm | 5.2mm |
| 22mm | 5.2mm |
| 24mm | 5.2mm |
| 26mm | 5.2mm |
| 28mm | 5.2mm |
| 30mm | 5.2mm |
| 32mm | 5.2mm |

用途: 压边包边
用途: 压边包边
Purpose: Binding of water bar with stitching
Machine: 3 or 4 Needs Water Bar Machine

标准厚度
Standard Thickness: M, SH, H

TL-204 A70/S70

压边式单针包边器
Spacing Strip Sewing Hammer



| 规格 |
|--------|
| 1 3/8" |
| 1 3/4" |
| 1 7/8" |
| 2" |
| 2 1/8" |
| 2 1/4" |
| 2 3/8" |
| 2 1/2" |
| 2 5/8" |

用途: 压边包边
用途: 压边包边
Purpose: Spacing binding sewing needle
Machine: 1 Needs Lockstitch machine

标准厚度
Standard Thickness: M, SH, H

TL-205

压边式压边器
Adjustable Cloth Guide



用途: 压边包边
用途: 压边包边
Purpose: Binding of knitwear collar cloth
Machine: 2 or 3 Needs Cover
Stitch Machine

标准厚度
Standard Thickness: M, SH

TL-222 (A400)

扣眼调节
Adjustable Cloth Guide

| 规格 |
|-------|
| 3/16" |
| 1/8" |
| 3/16" |
| 1/4" |
| 5/16" |
| 3/8" |
| 1/2" |

用途: 扣眼调节
用途: 扣眼调节
Purpose: Binding or adjuster cloth color
Machine: 1 Needs Lockstitch machine

标准厚度
Standard Thickness M SH H

TL-223 (A75D)

扣眼调节
Adjustable Cloth Guide

| 规格 |
|-------|
| 3/16" |
| 1/4" |
| 5/16" |
| 3/8" |
| 1/2" |
| 5/8" |
| 3/4" |
| 7/8" |
| 1" |

用途: 扣眼调节
用途: 扣眼调节
Purpose: Binding or adjuster cloth color
Machine: 1 Needs Lockstitch machine

标准厚度
Standard Thickness M SH H

TL-303 A30/121586(F335)

日字锤
Sewing Hammer

| 针距尺寸 |
|-------|
| 1/8" |
| 3/16" |
| 1/4" |
| 5/16" |
| 3/8" |

用途: 压脚
用途: 压脚, 扣眼调节
Purpose: General straight hemming
Machine: 1 Needs Lockstitch machine

标准厚度
Standard Thickness M SH H SH

TL-304 35800(F337)

带针压口锤头
Sewing Hammer

| 针距尺寸 |
|-------|
| 3/16" |
| 1/4" |
| 5/16" |
| 3/8" |
| 1/2" |
| 5/8" |
| 3/4" |
| 1/2" |

用途: 压脚
用途: 压脚, 扣眼调节
Purpose: General straight hemming
Machine: 1 Needs Lockstitch machine

标准厚度
Standard Thickness M SH H

TL-225

上下可调节压脚
Sewing Hammer

| 规格 |
|-------|
| 1/4" |
| 5/16" |
| 3/8" |
| 1/2" |
| 5/8" |
| 3/4" |
| 7/8" |
| 1" |

用途: 扣眼调节
用途: 扣眼调节
Purpose: General straight hemming
Machine: 1 Needs Lockstitch machine

标准厚度
Standard Thickness M SH H

TL-226

带口压脚
Sewing Hammer

| 规格 |
|-------|
| 1/4" |
| 5/16" |
| 3/8" |
| 1/2" |
| 5/8" |
| 3/4" |
| 7/8" |
| 1" |

用途: 扣眼调节
用途: 扣眼调节, 带下压脚
Purpose: General straight hemming
Machine: 1 Needs Lockstitch machine

标准厚度
Standard Thickness M SH H

TL-305 F334

带针压口锤头
Sewing Hammer

| 针距尺寸 |
|-------|
| 1/8" |
| 3/16" |
| 1/4" |
| 5/16" |

用途: 扣眼调节
用途: 扣眼调节
Purpose: General straight hemming
Machine: 1 Needs Lockstitch machine

标准厚度
Standard Thickness M SH H

TL-306/309

带针压口锤头
Sewing Hammer

| 针距尺寸 |
|-------|
| 3/16" |
| 1/4" |
| 5/16" |
| 3/8" |
| 1/2" |
| 5/8" |
| 3/4" |
| 7/8" |
| 1" |

用途: 扣眼调节
用途: 扣眼调节
Purpose: General straight hemming
Machine: 1 Needs Lockstitch machine

标准厚度
Standard Thickness M SH H

TL-301 A32

带针压口锤头
Sewing Hammer

| 针距尺寸 |
|-------|
| 3/16" |
| 1/4" |
| 5/16" |
| 3/8" |
| 1/2" |
| 5/8" |
| 3/4" |

用途: 扣眼调节
用途: 扣眼调节
Purpose: General straight hemming
Machine: 1 Needs Lockstitch machine

标准厚度
Standard Thickness M SH H

TL-302 F333

带针压口锤头
Sewing Hammer

| 针距尺寸 |
|-------|
| 3/16" |
| 1/4" |
| 5/16" |
| 3/8" |
| 1/2" |
| 5/8" |
| 3/4" |
| 7/8" |
| 1" |

用途: 扣眼调节
用途: 扣眼调节
Purpose: General straight hemming
Machine: 1 Needs Lockstitch machine

标准厚度
Standard Thickness M SH H

TL-403 AT112(F324)

带针压口锤头
Sewing Hammer

| 针距尺寸 |
|-------|
| 1/8" |
| 3/16" |
| 1/4" |
| 5/16" |
| 3/8" |
| 1/2" |
| 5/8" |
| 3/4" |
| 7/8" |
| 1" |

用途: 扣眼调节
用途: 扣眼调节
Purpose: General straight hemming
Machine: 1 Needs Lockstitch machine

标准厚度
Standard Thickness M SH H

TL-404 F340

带针压口锤头
Sewing Hammer

| 针距尺寸 |
|--------|
| 5/8" |
| 3/4" |
| 7/8" |
| 1" |
| 1 1/8" |
| 1 1/4" |
| 1 1/2" |
| 1 3/4" |
| 2" |

用途: 扣眼调节
用途: 扣眼调节
Purpose: General straight hemming
Machine: 1 Needs Lockstitch machine

标准厚度
Standard Thickness M SH H

TL-405 F339

剪字器
Snaring Hammer标准厚度
Standard Thickness M MH H用途: 加工金属
用途: 加工金属
Purpose: General straight hemming
Machine: 1 Needs Locksmith machine

| 入口 | 出口 |
|------|------|
| 10" | 14" |
| 8" | 12" |
| 3" | 3" |
| 1" | 1" |
| 1.5" | 3" |
| 1.5" | 3" |
| 2" | 1.5" |
| 3" | 1.5" |
| 3" | 1.5" |

TL-406 F342

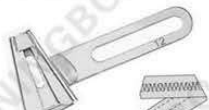
剪刀机打器
Snaring Hammer标准厚度
Standard Thickness M MH H用途: 加工金属
用途: 加工金属
用途: 加工金属
Purpose: General straight hemming
Machine: 1 Needs Locksmith machine

| 出口 |
|------|
| 8mm |
| 8mm |
| 10mm |
| 12mm |
| 13mm |
| 14mm |
| 15mm |
| 16mm |
| 17mm |
| 18mm |
| 20mm |

TL-407

木工剪字器
Snaring Hammer标准厚度
Standard Thickness M MH用途: 加工金属
用途: 加工金属
Purpose: General straight hemming
Machine: 1 Needs Locksmith machine

| 出口 |
|------|
| 10mm |
| 12mm |
| 13mm |
| 14mm |
| 15mm |
| 16mm |
| 18mm |
| 20mm |

TL-408

剪丝式咬字剪器
Snaring Hammer标准厚度
Standard Thickness M MH H用途: 加工金属
用途: 加工金属
用途: 加工金属
Purpose: General straight hemming
Machine: 1 Needs Locksmith machine

| 入口 | 出口 |
|------|------|
| 1.5" | 1" |
| 1.5" | 1" |
| 1.5" | 1" |
| 1.5" | 1" |
| 2" | 1.5" |
| 2" | 1.5" |
| 2.5" | 1.5" |
| 2.5" | 1.5" |

TL-409

剪刀机打器
Snaring Hammer标准厚度
Standard Thickness M MH H用途: 加工金属
用途: 加工金属
Machine: 1 Needs Locksmith machine

| 入口 | 出口 |
|------|----|
| 1" | 1" |
| 1" | 1" |
| 1.5" | 3" |
| 1.5" | 3" |
| 1.5" | 3" |
| 2" | 1" |

TL-410

剪刀机打器
Snaring Hammer标准厚度
Standard Thickness M MH H用途: 加工金属
用途: 加工金属
用途: 加工金属
Machine: 1 Needs Locksmith machine

| 入口 | 出口 |
|------|----|
| 1.5" | 3" |
| 1.5" | 3" |
| 1.5" | 3" |
| 1.5" | 3" |
| 2" | 1" |

TL-413

左右用脚踏剪丝器
Snaring Hammer

TL-414 A41

剪刀机打器
Snaring Hammer标准厚度
Standard Thickness M MH H用途: 加工金属
用途: 加工金属
Purpose: General straight hemming
Machine: 1 Needs Locksmith machine

| 剪丝尺寸 |
|------|
| 1" |
| 3/8" |
| 5/8" |
| 3/4" |
| 1/2" |

TL-416 F217

单脚踏剪丝器 (原寸半厚)
Snaring Hammer标准厚度
Standard Thickness M MH用途: 加工金属
用途: 加工金属
Purpose: General straight hemming
Machine: 1 Needs Locksmith machine

| 规格 |
|-------|
| 3/16" |
| 1/4" |
| 5/16" |
| 3/8" |

TL-417

剪刀机打器
Snaring Hammer标准厚度
Standard Thickness M MH H用途: 加工金属
用途: 加工金属
Machine: 1 Needs machine

| 剪丝尺寸 |
|------|
| 1" |
| 3/8" |
| 1/4" |
| 5/8" |
| 3/8" |
| 1/2" |

TL-409

剪刀机打器
Snaring Hammer标准厚度
Standard Thickness M MH H用途: 加工金属
用途: 加工金属
Machine: 1 Needs Locksmith machine

| 入口 | 出口 |
|------|----|
| 1" | 1" |
| 1" | 1" |
| 1.5" | 3" |
| 1.5" | 3" |
| 1.5" | 3" |
| 2" | 1" |

TL-410

剪刀机打器
Snaring Hammer标准厚度
Standard Thickness M MH H用途: 加工金属
用途: 加工金属
用途: 加工金属
Machine: 1 Needs Locksmith machine

| 入口 | 出口 |
|------|----|
| 1.5" | 3" |
| 1.5" | 3" |
| 1.5" | 3" |
| 1.5" | 3" |
| 2" | 1" |

TL-418 F313

剪刀机打器
Snaring Hammer标准厚度
Standard Thickness M MH用途: 加工金属
用途: 加工金属
Purpose: General straight hemming
Machine: 1 Needs Locksmith machine

| 入口 | 出口 |
|------|------|
| 1.5" | 3" |
| 1.5" | 3" |
| 1.5" | 3" |
| 1.5" | 3" |
| 2.5" | 1.5" |
| 2.5" | 1.5" |
| 2.5" | 1.5" |
| 2.5" | 1.5" |
| 3" | 1.5" |
| 3" | 1.5" |
| 3" | 1.5" |
| 3" | 1.5" |

TL-429 F408

剪刀机打器
Snaring Hammer标准厚度
Standard Thickness M MH H用途: 加工金属
用途: 加工金属
用途: 加工金属
Machine: 1 Needs Locksmith machine

| 入口 | 出口 |
|------|------|
| 1.5" | 1.5" |
| 1.5" | 1.5" |
| 1.5" | 1.5" |
| 1.5" | 1.5" |
| 1.5" | 1.5" |
| 2.5" | 1.5" |
| 2.5" | 1.5" |
| 2.5" | 1.5" |
| 2.5" | 1.5" |
| 3" | 1.5" |
| 3" | 1.5" |
| 3" | 1.5" |
| 3" | 1.5" |

TL-432 椅子脚 Beating Hammer



标准厚度
Standard Thickness M M H

| 入口 | 出口 |
|--------|-------|
| 3/4" | 3/8" |
| 1/2" | 1/4" |
| 3/8" | 3/16" |
| 1/4" | 1/8" |
| 1 1/4" | 3/8" |
| 1 1/2" | 1/2" |
| 1 3/4" | 5/8" |
| 1 5/8" | 3/4" |
| 1 3/4" | 7/8" |

说明: 适用于椅脚, 椅子脚, 油毡条
应用: 椅子脚
Machine: 1 Beater Lockfast machine

TL-433 F521 滚毡椅子脚 Beating Hammer



标准厚度
Standard Thickness M M H H

| 入口 | 出口 |
|--------|-------|
| 3/4" | 3/8" |
| 1/2" | 1/4" |
| 3/8" | 3/16" |
| 1/4" | 1/8" |
| 1 1/4" | 3/8" |
| 1 1/2" | 1/2" |
| 1 3/4" | 5/8" |
| 1 5/8" | 3/4" |
| 1 3/4" | 7/8" |

说明: 适用于椅脚, 椅子脚, 油毡条
应用: 油毡条
Machine: 1 Beater Lockfast machine

TL-438 F308 上下有嘴椅头脚 Beating Hammer



标准厚度
Standard Thickness M M H

| 入口 | 出口 |
|--------|--------|
| 1 1/4" | 1 1/4" |
| 1 3/4" | 1 3/4" |
| 1 5/8" | 1 5/8" |
| 1 3/4" | 1 3/4" |
| 1 5/8" | 1 5/8" |
| 1 3/4" | 1 3/4" |

说明: 适用于椅头
应用: 油毡条
Machine: 1 Beater Lockfast machine

TL-439 F525 宽片滚毡椅脚 Beating Hammer

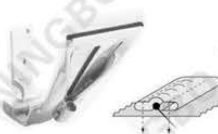

标准厚度
Standard Thickness M M H

| 标准尺寸 |
|------|
| 3/8" |
| 1/2" |
| 3/4" |
| 5/8" |
| 3/4" |
| 5/8" |

说明: 适用于椅脚, 油毡条
应用: 油毡条
Machine: 1 Beater Lockfast machine

TL-434 F510 椅头滚毡 Beating Hammer

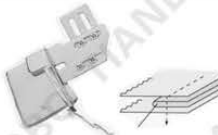

标准厚度
Standard Thickness M M H

| 入口 | 出口 |
|--------|-------|
| 1/2" | 1/8" |
| 3/8" | 3/16" |
| 1/4" | 1/8" |
| 1 1/4" | 3/8" |
| 1 1/2" | 1/2" |
| 1 3/4" | 5/8" |

说明: 适用于椅头
应用: 油毡条
Machine: 1 Beater Lockfast machine

TL-435 飞马滚毡椅子脚 Beating Hammer



标准厚度
Standard Thickness M M H H

| 入口 | 出口 |
|--------|-------|
| 3/4" | 3/8" |
| 1/2" | 1/4" |
| 3/8" | 3/16" |
| 1/4" | 1/8" |
| 1 1/4" | 3/8" |
| 1 1/2" | 1/2" |
| 1 3/4" | 5/8" |

说明: 适用于椅脚, 椅子脚, 油毡条
应用: 油毡条
Machine: 1 Beater Lockfast machine

TL-440 F526 宽边心椅头脚 Beating Hammer



标准厚度
Standard Thickness M M H

| 入口 |
|------|
| 1/2" |

说明: 适用于椅头
应用: 油毡条
Machine: 1 Beater Lockfast machine

TL-441 F512 宽边脚踏滚毡 Beating Hammer



标准厚度
Standard Thickness M M H

| 入口 | 出口 |
|--------|------|
| 1" | 3/8" |
| 1 1/2" | 1/2" |
| 1 3/4" | 3/4" |
| 1 3/4" | 1" |

说明: 适用于脚踏滚毡
应用: 油毡条
Machine: 1 Beater Lockfast machine

TL-436 F201 门脚脚 Beating Hammer



标准厚度
Standard Thickness M M H

| 入口 | 出口 |
|--------|--------|
| 1 1/2" | 3/8" |
| 1 3/4" | 1/2" |
| 2" | 1" |
| 2 1/4" | 1 1/8" |
| 2 1/2" | 1 1/4" |
| 2 3/4" | 1 3/8" |
| 3" | 1 1/2" |
| 3 1/4" | 1 3/4" |
| 3 1/2" | 1 5/8" |
| 3 3/4" | 1 5/8" |
| 4" | 2" |

说明: 适用于门脚
应用: 油毡条
Machine: 1 Beater Lockfast machine

TL-437 F307 上下有嘴椅头脚 Beating Hammer



标准厚度
Standard Thickness M M H

| 入口 | 出口 |
|--------|--------|
| 3/4" | 1" |
| 1 1/4" | 1 1/8" |
| 1 1/2" | 1 1/4" |
| 1 3/4" | 1 1/2" |
| 2" | 1 3/8" |
| 2 1/4" | 1 3/4" |
| 2 1/2" | 1 3/4" |
| 2 3/4" | 1 3/4" |
| 3" | 1 3/4" |
| 3 1/4" | 1 3/4" |
| 3 1/2" | 1 3/4" |
| 3 3/4" | 1 3/4" |
| 4" | 2" |

说明: 适用于椅头
应用: 油毡条
Machine: 1 Beater Lockfast machine

TL-443 带锯齿滚毡脚 Beating Hammer



标准厚度
Standard Thickness M M H

| 入口 | 出口 |
|--------|--------|
| 3/4" | 3/8" |
| 1" | 5/8" |
| 1 1/4" | 1 1/8" |
| 1 1/2" | 1 1/4" |
| 1 3/4" | 1 1/2" |
| 2" | 1 3/8" |
| 2 1/4" | 1 3/4" |
| 2 1/2" | 1 3/4" |
| 2 3/4" | 1 3/4" |
| 3" | 2" |

说明: 适用于椅脚
应用: 油毡条
Machine: 1 Beater Lockfast machine

TL-460 带锯齿扣 (带口) Belt Loop Forster for Belt Loop Machine with roller



标准厚度
Standard Thickness M M H H

| 出口 |
|------|
| 20mm |
| 25mm |
| 30mm |
| 35mm |
| 40mm |
| 45mm |
| 50mm |
| 55mm |
| 60mm |
| 65mm |
| 70mm |

说明: 适用于带扣
应用: 带扣
Machine: 1 Beater Belt Loop Machine with Ford Color

TL-448 狗胆状扁冲器
Beating hammerTL-453 耳杆槌
Beating hammerTL-454 筒子槌
Piping folderTL-456 多齿圆头器
Multi Edge Attach-ExpanderTL-458 MH-380双针扁器
Double Needle Taper Attaching FootTL-459 8927双针扁器
Double Needle Taper Attaching FootEASTMAN
625-629

602C1-9



10C1-41



71C3-15



580C1-70



597C2-14



627C1-10



87C3-44



87C3-8



87C3-50



87C3-40



71C3-18



532C2-5



34C1-20



4C2-113



4C2-112



90C4-58



90C4-51



20C12-143



20C12-113



11C12-92



87C5-13



147C1-29



11C12-64



87C3-53



580C1-85



579C2-17



53C4-78



53C11-72



85C3-6



79C12-163



621C1-7



22C1-24



706C1-5

508C1-101
523C1-101

580C1-198



71C1-10 62C1-140 553C1-8 22C3-2 17C15-113 35C7-28

712C1
712C1-1 820C1-7
820C1-8 70C4-32 664C1-6 68C1-192 532C2-3

525C1-2 53C11-91 60C1-56 53C11-60 85C1-52 728C1-5



607C1-35 727C1-6 79C4-24 147C1-26 716C1-12 531C1-53



11C12-56 11C12-57 643C1-43(8') 643C1-47(10')



732C1-12 713C4-4 715C1-23 62C6-31

KM
KS-AUV M-146A M-146B M-007 M-003 M-201

M-229 M-027 M-028 M-023 M-009 M-202



M-156 M-157 M-166 M-167 M-148 M-144



M-019 M-153 M-039 M-031 M-135 M-137



M-104 M-178 M-179 M-051 M-115 M-172



M-162 M-049 M-203 M-219 M-132 M-124



JUKI
DDL-8700

110-10311



110-39062



110-39070



110-40359



110-40508



229-37965



229-40506



229-40654



229-41306



229-44854



229-45356(铁螺母)



110-40953



110-41852



110-42850



229-00609



229-02159



229-03108



229-45463



229-47006



229-50257



229-50356



229-51164



229-71857



229-06200



229-06457



229-07307

229-07505
229-07604

229-07802



229-08354



229-10202

229-11408
229-41108

229-15003



229-49762



229-08800



229-10053



229-10350



229-10459



229-11606



229-11804



229-55553



MAS-07300-AAO



229-12257



229-12604



229-12752



229-15359



229-20508



229-20607

JUKI
DDL-9000

110-38809



110-42850



110-71800



229-06457



229-08008



B1306-155-OCO



229-20706



229-31703



229-37064



229-37155



229-37254



229-45463



236-00703



236-07302



236-09456



236-24158



236-09704



236-10207 236-10306 236-12054 236-12104 236-12302 236-13607



236-16055 236-16105 236-16550 236-16857 236-16907 236-17053



236-18051 236-18200 236-20503 236-20701 236-22061 236-23051



236-26351 236-27359 236-28357 236-31054 236-31302 236-33167



236-36061 236-36657 400-60794 23617053 236-39008



236-00604 236-18507 M6001-471-AA0 400-37180

JUKI
DDL-5200



113-32301 113-40304 B1190-522-S00 113-46905(3/32"-3/16") 113-47101(7/32"-3/4") B1191-522-A40(3/32"-3/16") B1191-522-W00(7/32"-3/8")



B1401-522-A00 B1524-522-NAA B1524-530-DA B4101-531-000 B4102-522-000 B4103-522-000



B4105-522-000 B4108-522-000 B4111-522-000 B4123-522-00A B4113-522-0A0 B4114-522-000



B4115-522-000 B4119-522-000 B4120-522-000 B4121-522-000 B4145-530-B00 B4132-522-000-A

JUKI
LH-512/515



B1114-051-000 B1118-512-00A B1118-512-00D B1118-512-00C B1131-512-000

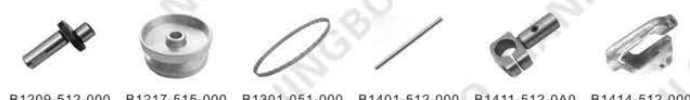

B1209-512-000 B1217-515-000 B1301-051-000 B1401-512-000 B1411-512-0A0 B1414-512-000



B1430-512-0A0 B1431-512-000 B1433-512-000 B1501-581-000 B1507-512-000 B1509-227-000



B1512-012-000 B1602-512-000 B1603-155-OA0 B1610-512-000 B1614-515-0A0 B1616-515-0A0



B1624-555-000 B1645-562-000 B1647-122-000 B1647-562-000 B1654-515-0A0 B1805-512-000



B1813-512-000 B1814-512-OA0 B1816-512-0A0 B1817-512-000 B1819-512-000 B1820-512-00A



B1820-512-00B B1831-512-000-A B1901-512-000 B3121-512-0B0 B3128-512-000 B3412-512-00A



B3414-552-000 B1103-512-0A0 B8217-512-000

JUKI
LH-1162



101-11805 102-00301 102-00529 102-00657 102-02703



102-06258 B1405-526-0A0 B1408-526-000 B1412-526-0A0 B1420-526-000 B3137-527-0A0



B1448-526-000 B1604-512-000 B1820-051-000 B1907-526-0A0 B1440-526-0A0



102-04170 102-15168



101-12001 103-15208 103-15455 110-06350 110-06756



110-71802 110-71701 110-71800 110-71909 226-00555 226-01058 226-03401



226-04201



226-04300



226-04508



226-04904



226-07006



226-07105



115-82558



118-00752



118-01859



118-02600



118-02907



118-04507



226-07204



226-08004



226-09002



226-09200



226-09309



226-09606



118-11304



118-11403



118-11601



118-14902

118-15503



118-19604



118-20305



226-09754



226-10000



226-10109



226-13509



226-17104



226-19001ASM



118-20404



118-23176



118-24208



118-24307



118-24406



118-24802



226-81050



226-82508



226-83056



226-89061



229-07703



118-25353



118-25908



118-26302



118-29355



118-29504



118-31674



B1501-581-000



B1603-512-000



B1604-012-000-A



B1636-581-C00



B1816-512-000



B1822-051-000



118-32458



118-32805ASM



118-33605



118-40808



118-41707



118-43208

JUKI
MO-2516

115-15053



115-15152



115-15459



115-21002



115-39053ASM



118-45153



118-45203



118-45302



118-45401



118-45500



118-46300







B1220-372-000c B1221-372-000 B1228-372-0A0 B1234-372-000 B1236-373-000 B1237-372-000



B1237-373-000 B1239-372-000 B1241-373-000 B4412-372-000 B1409-372-000 B1412-372-0A0



B1416-372-0A0 B2001-372-0A0 B2005-373-000 B2015-372-0A0 B2019-372-0A0 B2025-372-0B0



B2031-372-0A0 B2502-372-0A0 B2503-372-0A0 B2505-372-000 B2505-373-000 B2506-372-000



B2506-373-000 B2510-372-000 B2511-372-0A0 B4401-372-0A0 B2529-372-000 B2529-373-000



B2547-372-0C0 B2548-372-000 B2552-372-000 B2604-372-000 B2629-372-000 B2630-372-000



B2635-372-000 B4410-372-0A0 B2639-372-0A0 B3101-372-0A0 B3109-372-0A0 B3109-377-000



B4405-372-000 B2401-372-0B0 B2547-372-0B0 B8210-372-0A0



| | | | | | |
|-----------------|-----------|-----------|-----------|-----------|-----------|
| JUKI LK-1850 | 135-01309 | 135-03552 | 135-03750 | 135-04204 | 135-04501 |
|-----------------|-----------|-----------|-----------|-----------|-----------|



135-04551 135-04600 135-04709 135-06100 135-06258 135-06605



135-06704 135-06852 135-08551-ASM 135-09500 135-09708 135-09955



135-10367 135-10458 135-13155 135-14104 135-14401 135-15002

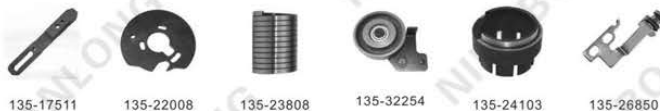



141-10308 141-10407 141-10811 141-13468 141-13666 400-06522



B1212-210-000 B1231-210-D00 B1812-980-0A0 B1901-280-0B0 B2306-210-D00 HD-0005700-0A



HD-0013500-00 M8540-590-0A0 141-00408 141-46054 141-90052



MAZ-15502000 B1230-210-D00



B1123-771-000 B1128-771-000 B1137-771-000 B1202-771-000 B1204-761-000



B1208-771-0A0 B1212-232-000 B1225-771-000 B1231-771-000 B1253-781-000 B1427-761-000



B1401-761-000 B1402-761-0A0 B1404-771-000 B1414-771-0A0 B1417-761-000 B1420-771-000



B1425-771-000 B1426-771-000 B1429-771-0A0 B1435-771-000 B1436-761-000 B1437-761-000



B1445-761-0A0 B1507-761-000 B1511-771-0A0 B1601-761-0A0 B1603-763-000 B1805-771-0B0



B1807-771-000 B1901-761-0A0 B2001-761-0A0 B2001-771-0A0 B2032-771-000 B2053-781-000



B2402-771-000 B2406-771-0A0 B2408-771-000 B2411-771-000 B2607-232-0A0 B2618-232-000



B2619-232-000 B2620-771-000 B2657-781-000 B2709-771-000 B2712-761-000 B2716-771-000



B2723-761-0A0-A B2730-761-000 B2903-761-000 B2904-771-000 B2906-761-000 B2910-771-0A0



B2919-761-000 B2920-761-000 B2928-761-000 B2932-761-000 B2940-761-000 B2944-761-000



B2951-781-000 B2952-781-000 B3103-771-0A0 B3110-771-0A0 B3151-781-0A0 B3258-781-0A0



B4419-372-000 B7160-781-0A0 B7252-781-000 HINGE B1105-771-0A0



B7180-781-0A0 B1112-771-0A0 B1138-771-000 B1403-771-000



B1415-761-000 B2401-771-0A0 B2901-761-000 B3251-781-0A0

JUKI
MS-1190



129-24700 129-31465 129-34014 129-34303 129-34402

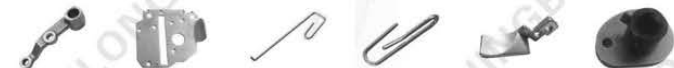

129-35011 129-35516 129-35904 129-36001 129-36506 129-37256



129-39559 129-41100 129-42009 129-42306 129-42504 129-42603



129-42900 B1207-191-A00 B1209-019-0A0 B1402-019-000 B1409-019-0B0 B1412-038-000



B1509-191-000 B1602-019-000 B1606-191-000 B1608-019-000 B1635-191-000 B1805-019-000



B2001-019-000 B2006-019-0A0 B2101-191-000 B2107-019-000 B2108-019-000 B2109-019-0A0



B2317-019-000 B2502-019-000 B2503-019-000 MAM-2950CCAA 129-22357



B1601-019-000 B2319-191-000

JUKI
MS-380



B1103-380-F00 B1104-380-A00 B1108-380-B00 B1121-552-0A0 B1122-552-000



B1206-481-0B0 B1402-552-000-A B1403-380-000 B1501-380-000 B1502-541-000 B1515-552-000



B1518-555-0B0 B1602-481-000 B1608-555-0A0 B1614-555-000 B1617-555-000 B1620-481-000



B1627-555-0A0 B1629-555-0A0 B1713-380-000-AB1901-481-000-A B1902-481-0A0 B1904-481-000



B1905-380-000 B2004-481-0A0 B2005-481-0AB B2005-380-0A0 B2006-380-0A0 B2007-380-0A0



B2008-481-000 B2010-481-000 B2014-481-0A0 B2210-481-0A0 B2220-480-0A0 B2309-481-0A0 B2313-380-000A



B3101-380-AA0 B3101-380-BA0 B3121-380-000 B3501-555-000

JUKI
LZ-2280



100-04208 100-08407 100-08753 100-12409 100-12508



100-16012 100-17317 100-26300 100-27001 100-27209 100-30401



100-30609 100-31003 100-35111 225-01506 225-05408 225-06208







SA1231-001



SA1144-001



SA1144-001

SA1272-001



SA1206-001



154593-001



SA4259-001



SA1214-0001



SA1171-001



SA1322-001

BROTHER
842/845
872/875



S38420-001



S38419-001



148495-001



S07330-001



S07417-001



148802-001



S38211-051



112656-051



S07338-001



S07368-301



149820-001



112592-001



112597-001



S07347-101



S38414-001



S07366-101



S07422-001



S07387-001



112593-001



112595-001



S07387-251



112596-101



S07511-001



112692-101



180157-001



149820-001



149613-001



112593-001



112595-001



S07364-001



S38272-001



S07373-001



141207-001



S31006-001



S07339-209



S00858-001



140527-001



S07489-001



S07330-001



143612-001



S07504-001



S07566-101



S34307-001



S34311-001



140527-001



144614-001



S12445-001

153604-001
153606-001

S07572101



112586-001

BROTHER
N31

S20625-001



S20652-001



S39711-001



S39724-001



S38313-001



146617-001



144079001



146482-001



140096-001



144073-001



S06561-001



S20576-001



S23628-001



S39688-001



S21130-001



S38311-100



S38305-001



144179-001



144619-000



146544-000



159638001



146532-001



159636-000



S39658-001



S20657-001



S20655-001



S20591-001



S39633-001



S39575-001



146421-000



144025-001



144044-001



148997-001



146654-001



146777-101



S37070-121



S20701-001



S20589-001



S39608-021



S39611-001ASM



146451-001



S01417-001



146754001



S09459-001



146497-201



S39562-001

S39574-001
S39571-021
S39648-021

S38308-121



146521-001



144085-001

BROTHER
551

147344-001



146480-001



144036-001



146476-101



S01223-001

BROTHER
430

151930-001



152702-001



153053-001



S07814-001



152695-201





SA3367-001 SA3435-001 SA3458-001 SA3499-001 SA3604-001 SA3628-001



SA3631-001 SA3655-001 SA4068-101 SA4187-001 SA6563-101 SA9301-001



XC5780-001 SA3364-001

BROTHER
917

S36625-001 S115008-000 S03436-000 S03427-101 S03414-001



S03433-001 S03476-101 S03568-001 S03720-001 S03405-001 S03549-001



S06057-001 S03544-001 S03528-001 S03526-001 S03522-001 S03442-001



S03533-001 S37439-001 S36617-001 S03501-001 S03613-001 S03516-001



S03517-001 S36616-001 S03387-001 S03382-001 S36699-001 S03719-001



S03445-001 S03488-001 S36696-001 119270-001 S03446-001 S03448-001



S03463-001 S03567-001 S36626-001 S03415-001



S03635-001 S07877-001



S16482-001 111056-001 S40378-051 S40379-051 S40380-051



S40310-001



S40342-001



S40291-001



183949-001



S40819-001



S06315-001



111022-001



S06259-001



105131-001



S40301-001



S40300-001



111189-001



S41311-051



111082-051



105076-001



105177-001



S40798-050



111078-001



150712-001



150717-000



105284-101



S40792-001



105193-101



111095-009

105221-001
111070-001
111072-001

S40265-001



150659-001



S40375-001



S40376-001



S40377-001



150688-001



S40303-001



181993-001



S40285-001



111019-000

BROTHER
814

141496-001



115544-001



141659-001



141575-001



141462-001



141619-001



141369-201



S32999-001



141484-001



141714-001

141490-001
141492-001

147565-001



141557-002



141430-004



141290-001



143740-001



S51182-001



141455-201



141335-001



141509-101



S56341-001



141522-001



141347-001



S32997-101



143739-004



141389-001



141368-001



145246-001



141367-001



141342-000



141533-001



141286-001



141518-004



141283-001



115545-001



BROTHER

981/982





SA7535-001 SA5673-001 SA7089-001 SA5671-001 S35167-001 S34888-001



S35066-001 S35132-001 S35337-001



SA6657-001 S35310-001 S43192-001

BROTHER
HE-800

S50664-001 S51249-001 159158-051 S50237-001 S50235-001



113316-001 S37100-302 S37101-001 S55347-001 S51182-001 S51183-001



S50161-000 S00306-001 S50174-001 S50218-001 S50252-001 S50258-1-01



S50259-101 S50404-301 S50294-001 S50375-001 S50383-001 S50385-001



S50417-001 S55184-001 S50149-001 S50657-001

PEGASUS
W500

252522 257553 256039 253584B-ASM 253516ASM



253514 25451692 254010C9U 253544 206059A 251003



262541ASM 253548 253501A92 25200892 250543 252000-92



25360891 252504 206562 25200992 25550192 254511



306093 256012 252002 250511-91 257565 206023



263551ASM 252500-91 252502-92 252533-92 253504 251518



206053 251519 206061 206139 255019 252007-92



207065A91 206233 254506 206052 206564 254508



254503 252527-91 206439 255015 250523ATD 252509



255507-91 255509 252521 250022-UB 255040-91



254023D9U 250032-SD 253000ASM 254000-91



PEGASUS W600 252642 306394 252053-92 251510 251513



251511 255107 252609 252035 252608 252612



252046-92 252001 253500 250557-91 252036 253607-91



252618-91 255560 252628 250167 252037-91 206050



252622 250525 252646 252643 252040 252045

PEGASUS
M600



204865A



208001AUD-E



208610



205466



209566-92



209567-92



209568-92



209569-92



209570-92



209594ASM

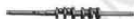

208951



209596



209600+209599

209601
273504

209603-91



209613-D



209612-D

PEGASUS
M700

179498-92



204122



204123A



204124



204140A



209689-92



209664



209665



209672



275034



209681ASM



204636B



204638



208402



208425



209542



208851



210529-9U



275016



274016A



275035



209576-91



209007-91



209452



209514-PD



206457



209544-92



209545-92



209550-PB



209610-91



209620-4A



275033ASM



209546-92



209552



209556-91



209560-92



209563-92



209564

PEGASUS
3200

179713-05



211528



212268-A



270012



270013



270034+270032 270043 270504 274505 270505-91 270507-91



273003 271004 271006(T) 271007 271016 271018-91



271500-92 271502-92 271505-92 271510+271511 271513-91 272000-92



272001-92 272500ASM 272509 272510-91 272514 272522



272525+240303 272529 272530A-92 272533 273000-92 273002-92



273008 273500 273501 273502 273505-92 274000-B



274001 274011 270523AO 275008 275017 275024



275027 275042 275004ASM 275506 272527 272528



270011AUDASM 270024 270035E 270512A



271000-92 270019 270069-91

SIRUBA
737/747
/757

AKU27 KC22B KC23B KC67 KD04E



KD09 KD17 KF01 KF09 KF17 KF23



KF25



KF28



KF33+KF32



KG04F



KG11F



KG12-E



KQ07



KQ10



KQ28



KQ37



KS26D-2D



KQ40



KG31D



KG35



KG37



KG42



KG54



KG59



KR01



KR09



KR13



KR19



KR20



KR26



KG60F



KG471



KG472



KG1821A



KJ01B



KJ09B



KR27



KR33



KR36



KS01



KS02D



KS09



KJ09E



KJ20



KJ22



KJ26+KJ30F



KJ68



KJ42F



KS28



KS29



KS30D



KT04



KD01



KL09B



KL12



KL12B



KL23



KM01



KM28



KB01E



KB22D



KB22E



KC09D



KN01



KN08



KN18-E



KS14D



KP23



KQ05



KC09E



KC09F



KC21-E



KT03-E

SIRUBA
F007/C007

MF29E



MA10J-E



MC41



MC44



MC64



MH43



MH49E



MH50E



MH52E



MH64



MH66



MC66-E



MC83



MC86



MC93D



MD04



MD08



MH81



MK01-E



MS31-E



MT02



MT20



MT24



MD17



MD22



MD23-2



MF23D



MD26-2



MD28D



MV03



MV08



MV16-E



MV18



MV25



ML05-E



MD30J



MD37



ME05



ME16



ME30



ME70



FQ01-E



MA16E



MA21-E



MR07J



ME79



ME85



MF01



MF09



MF13



MG05



MG31



MG35-E



MH03



MH07D



MH08



MH19

SIRUBA
VC008

VA06



VB04



VC02



VC07



VC14D



VC16



VC22D



VCL01+VCL02



VCL05



VCL41



VD01





YAMATO
VG2700
VG3721



KASAI
1404

02-101ASM



04-106



19-401



19-403ASM



19-411



81-182

87-004
88-003

1404 OIL PUMP



71-842



31-155



31-222



31-409



39-233



51-013



55-141



27-018



41-136



69-105



71-747



55-146



60-343



61-312



61-241



61-532



61-711

KASAI
1508

07-743



07-744



18-581



19-289



19-302



61-714



63-232



63-241



63-353



63-511



63-517



45-132



45-429



45-438



45-442



60-080



61-208



63-713



66-111



66-116



67-147



67-311



69-216



61-322



63-208



63-621



63-711



63-713



71-901



71-542



71-913



71-933



73-121



77-133



81-181



19-314



19-316



55-051



67-172



67-223



67-501



87-754 40-3540 55-041 55-155 21-972

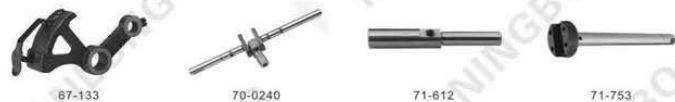

67-133 70-0240 71-612 71-753

SINGER

20U



52016 52024 52454 54178 56024



410004 410007 410015 410028 410037 410040



540472 505326 505335 505339 410056 541806



541607 541685 541689 543914 543944 541651



541623 541688 541645 541750 541754 541646



541778 541910 541946 541957 541967 543904



543906 543907 543908 543971 543921 543928



543937 543938 543939 543941 541620-452 541773-452



543977 543978 544255 545766 546828 546881



410060 505322 505327 541921



541985



543942



546950

SINGER
457

210505



210569



282142



368029



411025



411005



411007



411009



411015-451



411016-451



411046



411030



411285



411037



411045



411002



411306



411174



411147



411192



417895



502509



502704



411358



411360



411362



411364



411394



411396



4111480



4111482



411035



411061



502545+502546



502587-002



411074



502720



502768



502839



502844



502847



502866



502990



508943



509087



411073



502948



502993



508880

SINGER
299

543232



548231



548205



548207



548059



548071



548206



548208



548245



548357



548359



548216 548432 548486 548503 548719 548381

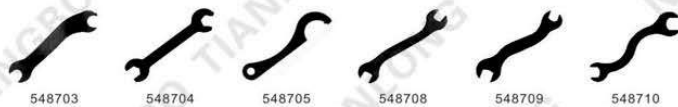

548382 548442 548510 548531 548532 548535

548936 544599 548886 548575 544531 548707
548576 548601

548703 548704 548705 548708 548709 548710



548711 546657 548803 548885



548539 548983 548984 548995 548175



548918 548591 548912 548915



548304 548911

SINGER
191/591

44731 143058 174488 410718 410721

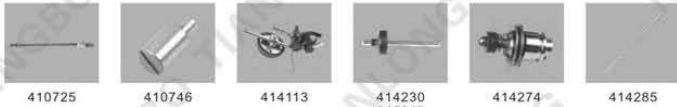
410725 410746 414113 414230 414274 414285
545912

414288 414296 414314 414317 414471 505649



540524 540537 540549 540606 540617 540629



540635 540644 540648 540652 540653 540660



540676 540677 540702 543367 543416 543493



544424 544425 544901 544934 544967 544980

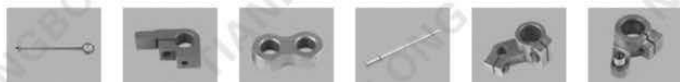

545059 545099 545788 545791 545807 545808



545841 545847 545849 545856 545864 545868



545884 545892 545949 545987 547242 549380

SINGER
974

37239 37245-900 37281-901 37288 37977



37990 44366-900 44392 44437 44453-900 44512



44856-901 X402891 317398 44873-001 44635-474 445054-040



44879-481 66774-002 317294-453ASM 113531-451 37235-900 445543



137507-901 137508 317419 278304 276305 276306



276302 310799-902 310903-451 317432-900 317454-002 X446021



319695 44915-901 445464 445671ASM 445790 445124-1



445147-900
445149-900 445599 445646 445778-901 445803 445810-901



445815 445860 445871ASM 446357 X445865 531667



4446176 4449026 4461720 X445941
X445940-900 X446025 44561



44908 X37833-002 444893
446091-900 X445925 X445943 X445945



446152-901 446152-901-1 X445946 37926 X446019 445776-900
445778-901



X445947-001 X446023-1 445776-900
445778-901 X446023 X446258 X446925ASM



SINGER
JA1-1
JA2-1

HA1-2 HA1-3 HA1-5 HA1-11 HA1-13



HA1-15 HA1-15A HA1-17 HA1-17A HA1-19 HA1-20-1



HA1-23 HA1-24 HA1-27 HA1-30 HA1-31 HA1-32



HA1-33 HA1-35 HA1-36 HA1-37 HA1-40 HA1-41



HA1-42 HA1-47 HA1-51 HA1-51-1 HA1-51-1LG HA1-51LG



HA1-53B HA1-54 HA1-57 HA1-61 HA1-70 HA1-71B

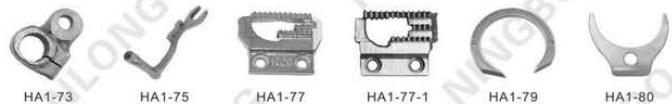

HA1-73 HA1-75 HA1-77 HA1-77-1 HA1-79 HA1-80



M1230-2A HA1-83 HA1-86 HA1-87-1 HA1-87-3 HA1-87-4



HA1-93 HA1-93AD HA1-93DD HA1-103-1 HA1-103-2 HA1-105



HA1-106 HA1-107 HA1-114 HA1-117 HA1-124 HA1-132



HA1-135B HA1-155E HA1-202 HA1-203 HA1-204 HA1-204-1



55705 HA1-1 HA1-26 HA1-38



HA1-39 HA1-66 HA1-71A HA1-72



HA1-90 HA1-91 HA1-126 HA1-144-147



KINGTEX SH-7000 6030224D600 6030321C200 6030322C200 6030330D100 6030333D100



6030334D100 6030339A100 6030340A100 6030410A100 6030406A100 6030407A100



6030426A100 6030435B200 6030436A300 6030437D100 6030451D700 6030515A100ASM



6030611A100 6030612A100 6030613A100ASM 6030632C200 6030714D100 6030733E200



6030734B300ASM 6030902E200 6030907B700 6030910A100 6030901A101 6030917A300



6031001E200 6031101A 6031214E200 6031229B700 6031301A100 6031305A100



6031312E200 6031512A200 6040711A100 6050134B700 Bb17401200 SN56320500A



GUIDE 6030101C700 6030118B700 6030137C200



6030207D600 6050311A300 EG001

DURKOPP
558

0558 tention set 05582301 0558000007 0558000478 0558000503



0558001116 0249000136 0557000600A 0557000855 0558000024 0558000171B



0558000173 0558000233 0558000245 0558000304 0558000306A 0558000307A



0558000308A 0558000309A 0558000310A 0558000324 0558000386 0558000461



0558000531 0558000587 0558000843 0558000866 0558000923 0558001135



0558001151 0558001186 0558001228 0558003821 0558003826 0558005016



0558006079 0558006192 0558007839 0558007840 0558009416 0558201106



0578000171 0578001504 0558000171B 0558200193 0578000231



055800479 0558000248 0558001221 0558006182



0558007771

REECE
101



D4 D5 D6 D7 D8



D9 10-1023-3-000 10-1075-1-000 14-4025-0-901 10-3050-0-000 10-3053-1-000



10-1033-1-000 10-1038-2-000 10-1069-0-005 10-1069-0-052 10-1091-0-000 10-1095-3-000

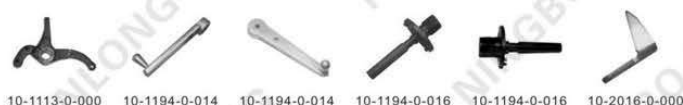

10-1113-0-000 10-1194-0-014 10-1194-0-014 10-1194-0-016 10-1194-0-016 10-2016-0-000



10-2016-0-000 10-2027-1-000 10-2028-1-000 10-2044-0-002 10-2046-1-000 10-2048-0-002 10-2050-1-750 10-2061-0-000 10-2260-0-200



10-3009-0-000 10-3031-0-000 10-3034-0-258 10-3039-0-000 10-3045-0-000 10-3067-4-254



10-3070-0-250 10-3072-0-014 10-3072-0-024 10-3252-1-000 10-4002-0-000 10-4011-0-200



10-4012-0-001 10-4012-0-004 10-4012-1-001 10-4012-1-004 13-1232-0-000 14-1041-0-000

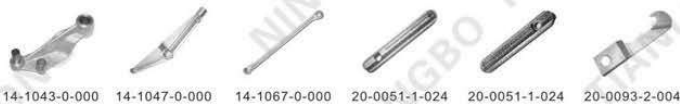

14-1043-0-000 14-1047-0-000 14-1067-0-000 20-0051-1-024 20-0051-1-024 20-0093-2-004



20-0093-2-004 20-0195-0-000 10-4010-2-000 14-3064-0-001 14-1035-0-050



14-4001-0-904

UNION
SPECIAL
35800

35876AC 29101 29478BY 35816 35820BQ



35824BQ 35826BQ 35826E 35826M 35826U 35873X



35848B 35848D 35848E 35856A 35859C 35859D 61257G

35873Z 35875D(thick)
35875B(thick) 35875D(thin)
35875B(thin) 35875NP 35876AE 35876AG

35876AH 35877A 35877B 35880K 35880P 35883J

35897BY 36293B 54279 56354A 35878S
35817E

29478AJ 35722AF1 502948 35822T

810/820 810new plate 12003(4)
12006(4) 12003
12006 12264 12265

12267 810003 810007 810017 810018 810019



810078 810082 810085 810086 810093 810094



810095 810096 810097 810104 810116 810117 810120



810124 810125 810129 810153 810156 810908 810909



810167 810170 810187 810198 810202 810204



810213 810222 810248 810249 810250 810253



810254 810255 810258 810270 810289 810296



810297 810300 810303 810317 810332 810333 810609



810820 810902 810903 810904 810817



820GAUGE 810135 810214 810251



810252 810257 810269 810280



810287 810295

PPAFF
335
 335009 335018 335034 335040 335044 335045 335047 335048



335062A 335062B 335107A 335107B 335068 335070
335063A 335063B 335127A 335127B



335071 335074+335075 335080 335082 335084 335086



335100 335120 335133 335122 335126 335128



335132 335134 335143 335029 335121 335018



335020 335030 335065 335066 335069 335070 335072 335073



335119 335099 335102 335103 335109 335112



335114 335118 335037 335038 335061



335027 335078 335078 335064



8810/8820 J6051-0B A1055-0A BWGE4E03 (单) BWGE4E01 (双) J1051-0A J1060-0A



J1064-0A J1067-0A J1065-0A J1066-0A J1074-0A J1075-0A



J1103-0A J1105-0A J1106-0A J1082-0A J1081-0A J1090-0A J1185-0A



J1200-0A J1206-0A J1213-0A J1213-1A J1213-3A J1219-0A



J1270-0A J1306-0A J1335-0A J4045-0A J4046-0A J1425-0A



J1428-0A J1430-0A J1431-0A J1482-0A J6018-0B J1501-0A



J1515-0A J1515-1A J4017-0A J4340-0A J4341-0A J4360-0A



J4280-0A J4330-0A J6015-1A J6016-0A J6031-0A J6032-0A

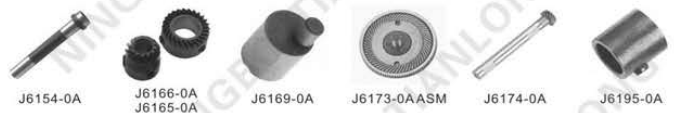

J6154-0A J6166-0A J6165-0A J6169-0A J6173-0AASM J6174-0A J6195-0A



J6050-0A J6050-1A J6051-0B J6150-0A J7021-0A J7032-0A

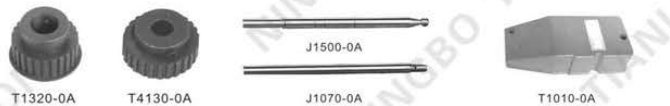

T1320-0A T4130-0A J1500-0A T1010-0A



PFAFF 474/1471 91-138513-91 91-500250-71 91-266397-01 91-119681-91 91-263392-91



91-150737-93 91-119458 91-263294-05 91-263310-05 91-119494-05 91-119136



91-150728-93 91-010023-05



801 M1183-0A M1105-0A M1108-0A M1180-0A 45°



M1230-2A M1230-3A M1231-0A M1231-4A M1231-5A M1231-40A



M1322-0A M3022-0A M4010-1A M4012-0A M4013-0A M4020-0A



M4021-0A M4025-1A M4026-0A M4092-0A M4071-0A M4071-0A(METAL)



M4071-0A(RED) M4071-0A(WHITE) M4071-1A M4072-0A M4073-0A M4076-0A



M4087-0A M4090-0A M4094-0A M4041-0A M4098-0A M4106-0A M4120-0A



M4220-0A M4222-0A M4223-0A M4224-0A M4332-0A M7110-0A



ZSK15009 ZNS15002 ZSK15010 M6110-0A 810269 810280



810252 810257



NEWLONG NP-7 GK26-1 24621+245081 241083 241092 242011A 242051A



242101A 242181 242231A 243012 243071 243081



243092 243102 243111 243151 244011A 244081



244122 245014 245033 245042 245081A 246011



246061 2450022 C02001 D03003 241024A



241102



242121



242201



243032



245052ASM



C01028



F01002



DT0216-001



DT0218-001



ST-15



ST-9000



602C1-9



7-60-2733-01



7-60-4508-01



DT0007-001



DT0027-001



DT0030-001



DT0108-001



DT0115-001



DT0117-001



DT0118-001



DT0119-001



DT0122-001



DT0131-001



DT0135-001



DT0138-001



DT0143-001



DT0145-001



DT0149-001



DT0150-001



DT0155-001



DT0207-001



DT0317-001



DT0338-001



DT0311-001



DT0024-001



ST-9000

IRON & PARTS



2128 ES-300 ES-300L ES-85AF ES-94AL ES-94A



ES-520 BS-3PC BS-6PC BSP-200 BSP-300 BSS-600



2128 ES-85AF ES-300L ES-520 BSP-200 STB-2000



BS-3PC BS-6PC ASL-610 ASL-630 ALU-1 ALU-2



ALU-3 ALU-4 ALU-5 ALU-6 ALU-7 ALU-8



ALU-9 STEAM HOSE I STEAM HOSE II SILICONE IRON REST 2003 BASE SET 2128 HANDLE SET



94A HANDLE SET 94A THERMO SHIELD 300 THERMO SHIELD 94A WATER BOTTLE VALVE SET 300 HANDLE SET THERMOSTAT SET



HANDLE SWITCH 1 300 MAIN SWITCH SET 300 SOLENOID VALVE 94A HANDLE CAP SET HEATING ELEMENTS (2128) HEATING ELEMENTS (STB-200)

CLEAN GUN & PARTS



TL-170 TL-120 TL-120A



TL-170A 10. Front Body 3. Drive Unite Compl 21. container 22. Suction Tube with Strainer 4. Switch 8. Control Knob ASM 12. Adjustable Roller spring 13. Pump Cylinder Compl



14 Pist Compl 15 Piston Spring Delivery Valve ASM 20 Bend, Nozzle 20. Nozzle Head Pump Cylinder ASM

TAG GUN & PARTS



3S 3X 5S 7S 7X 8S



8X 8XL 9L 11L 11X FX



YH-202 YH-203 YH-204 NTT-SW Looper Pin

LP-3 INCH
LP-5 INCH
LP-7 INCH
LP-9 INCH
LP-12 INCH
LP-16 INCH
LP-18 INCH



TAG PIN

PP
W/OLOK

| | |
|------|-------|
| 5MM | 25MM |
| 7MM | 35MM |
| 8MM | 50MM |
| 9MM | 65MM |
| 10MM | 75MM |
| 12MM | 100MM |
| 15MM | 125MM |

MORTO & PARTS



Clutch morto

FM2090

FM2090B

FM2090W



Overlock morto

Portable morto

SKT290D

SKT1002

CORKA



CORK B

CORKA SHEET A

CORKA SHEET B

CORKA SHEET C

BRAKE SHHE B

BRAKE SHHE A



143UT

143UT(A)

27640NS

MORTO SCREW

BOLT SPRING WASHER

ABSORBING RUBBER



CAPACITOR®

CAPACITOR(F)

PULLER

250V
450V

| | |
|------|------|
| 8UF | 18UF |
| 10UF | 20UF |
| 12UF | 24UF |
| 14UF | 25UF |
| 16UF | 28UF |

| | |
|------|------|
| 8UF | 18UF |
| 10UF | 20UF |
| 12UF | 24UF |
| 14UF | 25UF |
| 16UF | 28UF |

| | |
|------|-------|
| 45MM | 80MM |
| 50MM | 85MM |
| 55MM | 90MM |
| 60MM | 95MM |
| 65MM | 100MM |
| 70MM | 110MM |
| 75MM | 120MM |

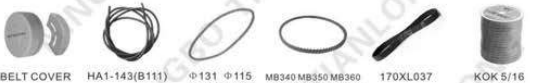

BELT COVER

HA1-143(B111)

φ131 φ115 φ119 φ150

MB340 MB350 MB360 MB430 MB440 MB450

170XL037

KOK 5/16 KOK 3/8



V-belt

T75(switch)

T75C(switch)

CARBON BRUSH

PULLER ATTACHMENT



02-178 02-208



02-222 02-207



02-473 02-478



02-474 02-479



02-181 02-197



02-471 02-476



1404 4N (Nylon)



1404 4N(PU)



1404MD



1508



1412 12N (PU)



1412 12N(Nylon)



VC008 4N(PU)



VC008 12N(PU)



VC008 12N (Nylon)



VC008 12N



VCL08P VCL33



VCL16P VCL28



W600(Nylon)



W600 (PU)

ATTACHMENT



7W bulb



LD-507



LD-508



LD-21



LD-27T



LD-98T



LDA1



LDA2



TL-11



37919(D701A)



37919P(D701B)



990474(D702A)



990474-011P(D702B)



D402A



D402B



D402C



TWE-1



TWE-6



TWE-7



TWE-8



SC-WH



SCB-20



HA3



A109



NTP-10



Absorption pen(L)



Absorption pen(M)



Absorption pen(S)



P010



PLASTIC OILER(B)



PLASTIC OILER(S)



STEEL OILER(B)



STEEL OILER(S)



AP30E



CL-12

CL-1

CL-2

CL-3

CL-7

CL-70

CL-4AA CL-6AA
CL-8AA CL-10AACL-4S CL-6S
CL-8S CL-10S

45N

50N

G1

G7



G8

K601

AP11E

G20

BC-HA1

MG1



MG20L

BC-LK(J3)

212TM

242TM

D101

量相尺



10-004

12-260



B-95

B-97

B-75



A95-B

A95-P

A95-V

A96-B

A96-P

A96-V



AT10-PE

AT10-VB

AT10-VE

AT10-VP

WHITE(ERASER)

INK CLEANER



Extensible pencil

Padan chalk

Rabbit chalk

BR1

BR2

109R



110R

111R

112R

114R

115R

TC755



TC832

AP18

AP18E

safe glove(3)

safe glove(5)

PU10

CWT22
(A6T7)

翻领机

K901

AM2





8500



8700



5550



500-01CB



500-02BB



600-01CB



5200



7200D



842



C007



F007



335A



845



20U53



700-3/4/5



373



1850



781



737/747/757



EX5200-4T



M0-6700



801



928PL



2284



810



9910



1412



JH820



JH920



JH974



808



CM-500



20S



JH988



810



810D



GN1-1D



GN1-6D



GN1-114D



810E



810L



TL-1300吸风烫台



JA2-2

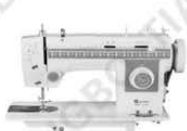

JH205



JH307



WJ-2007



WJ-9000



熨台



TL-38



GY10-1



YJ-50



BK-900



TL-911A



TL-933



YJ-65



YJ-70A



YJ-90A



GK9-2



GK26-1A



GK26-2A



YJ-90B



RS-100



YJ-D108A



标签机



穿针器



热切剪



烘线机



CZ1-20



CZD-3



CZD-103